

TO-92LM PNP Silicon PNP transistor in a TO-92LM Plastic Package.

High DC current gain and excellent h_{FE} linearity, low saturation voltage.

Strobe flash, medium power amplifier applications.

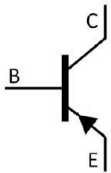

PIN1 Base PIN 2 Collector PIN 3 Emitter

h_{FE} Classifications Symbol	A	B	C
h_{FE} Range	140~280	200~400	300~600

Parameter	Symbol	Rating	Unit
Collector to Base Voltage	V_{CBO}	-20	V
Collector to Emitter Voltage	V_{CEO}	-10	V
Emitter to Base Voltage	V_{EBO}	-6.0	V
Collector Current - Continuous	I_C	-2.0	A
Collector Current – Continuous(Pulse)	I_{CP}	-4.0	A
Base Current - Continuous	I_B	-2.0	A

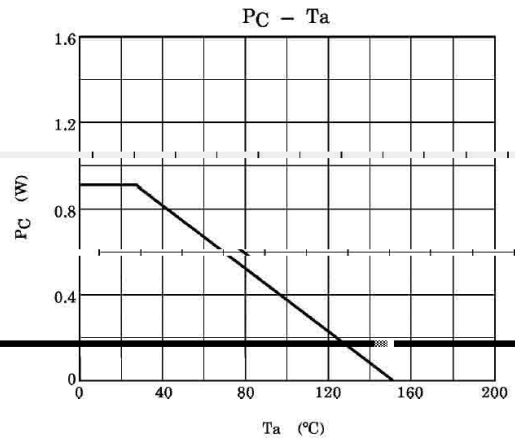
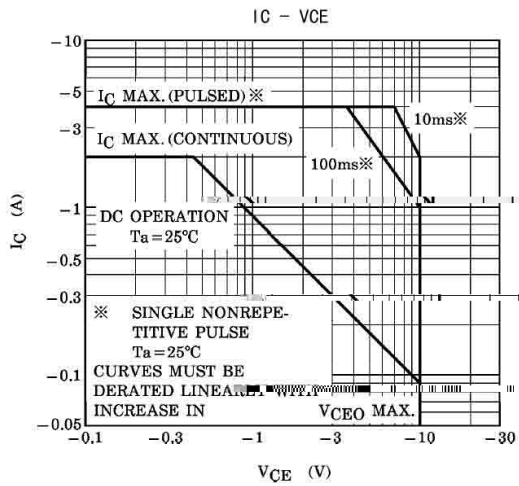
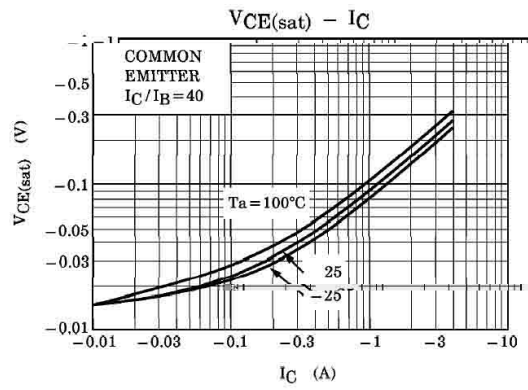
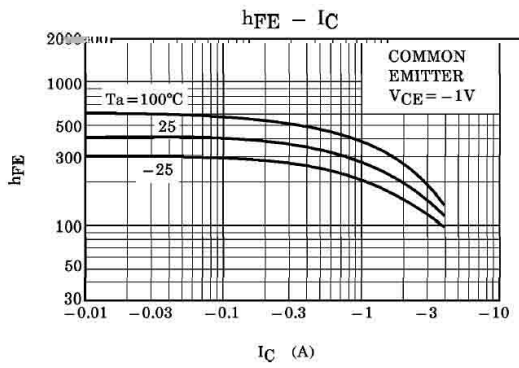
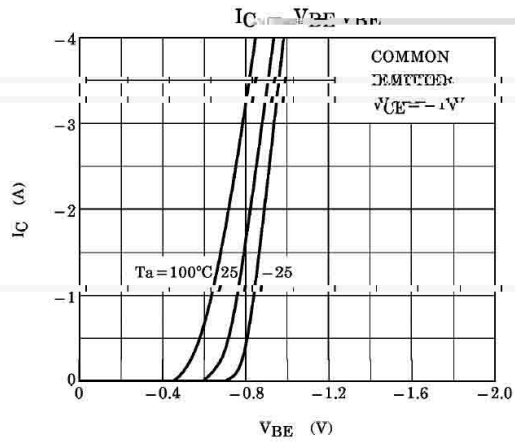
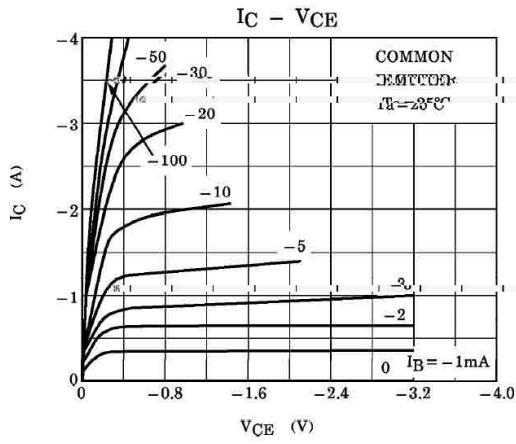

TO-92LM

Unit: mm

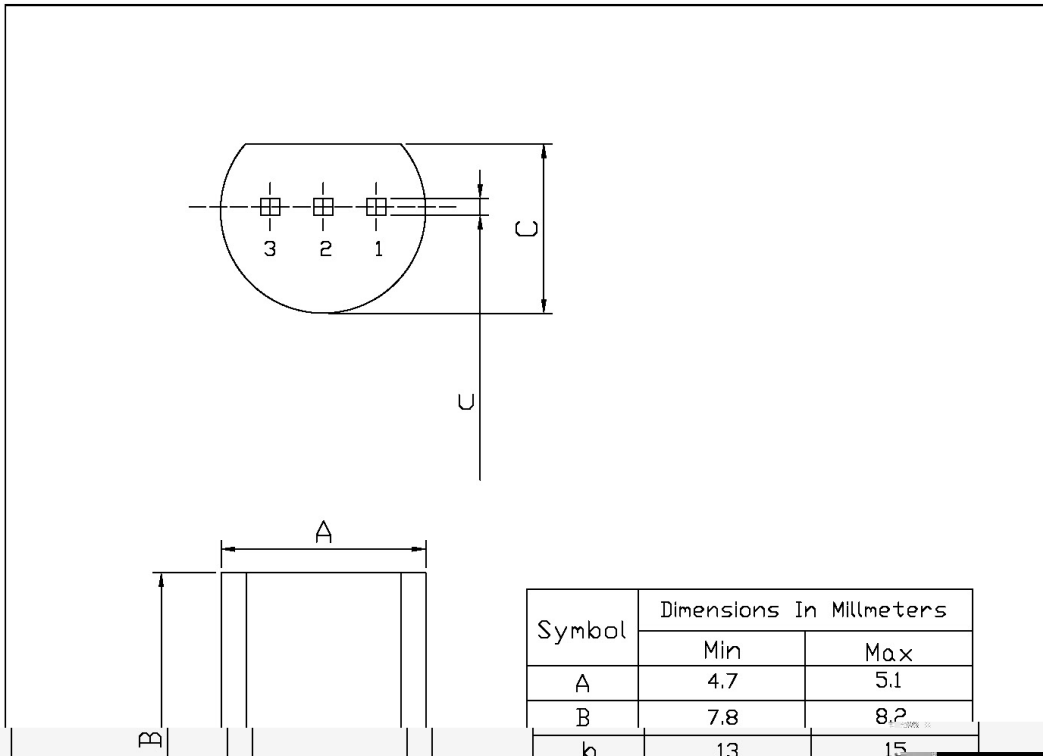

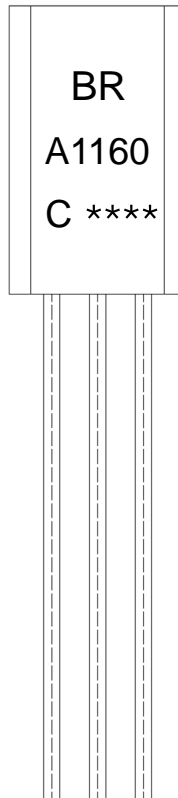

BR:

A1160

C: h_{FE}

Note:

BR: Company Code.

A1160: Product Type.

C: h_{FE} Classifications Symbol

****: Lot No. Code,code change with Lot No.

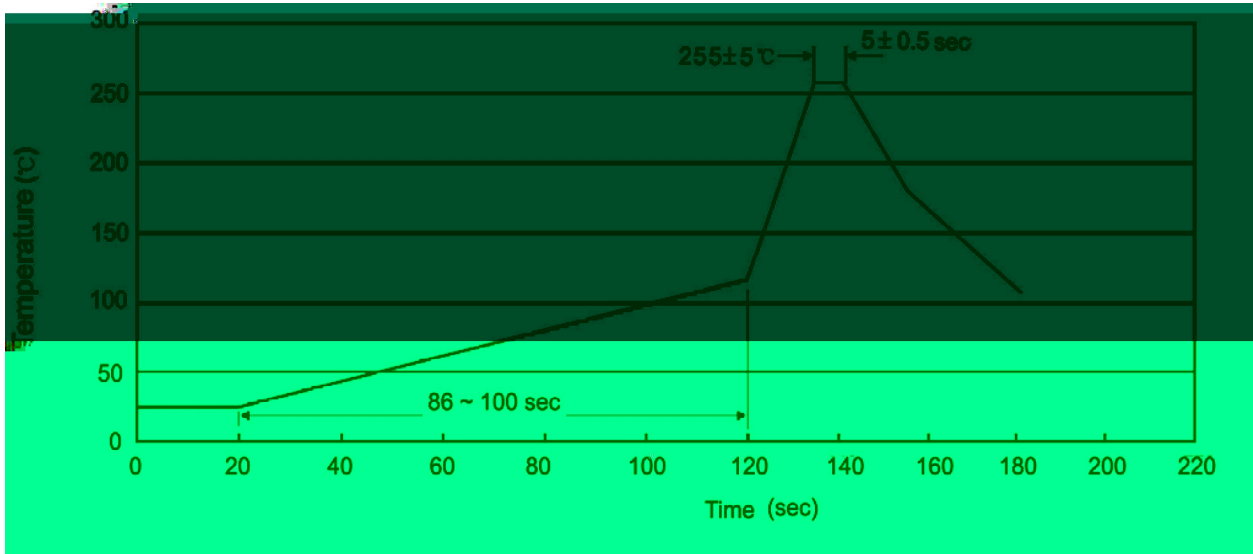
Note:

- | | | | | | |
|---|-------|-----|-----------|--------|---|
| 1 | 25 | 150 | 60 | 90sec; | 1.Preheating:25~150 , Time:60~90sec. |
| 2 | 255±5 | | 5±0.5sec; | | 2.Peak Temp.:255±5 , Duration:5±0.5sec. |
| 3 | | 2 | 10 | /sec. | 3. Cooling Speed: 2~10 /sec. |

270±5

10±1 sec.

Temp.:270±5

Time:10±1 sec

/ BULK

Package Type 封装形式	Units 包装数量					Dimension 包装尺寸 (unit: mm3)		
	Units/Bag 只/袋	Bags/Inner Box 袋/盒	Units/Inner Box 只/盒	Inner Boxes/Outer Box 盒/箱	Units/Outer Box 只/箱	Bag 袋	Inner Box 盒	Outer Box 箱
TO-92LM	1,000	8	8,000	5	40,000	135×190	237×172×102	560×245×195

/ AMMO

Package Type 封装形式	Units 包装数量					Dimension 包装尺寸 (unit: mm3)	
	Units/tape 只/纸带	Tape/Inner Box 纸带/盒	Rows/Inner Box 纸带层/盒	Inner Boxes/Outer Box 盒/箱	Units/Outer Box 只/箱	Inner Box 盒	Outer Box 箱
TO-92LM	2,500	1	100	10	25,000	328×230×42	小箱 480×346×235 大箱 547×407×268