

TO-92LM

NPN

2SA1124

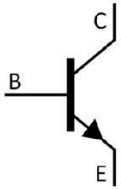

	~	~



			°C
		~	°C



		μ				
						μ

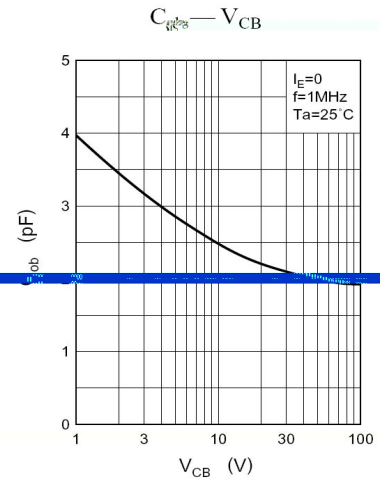
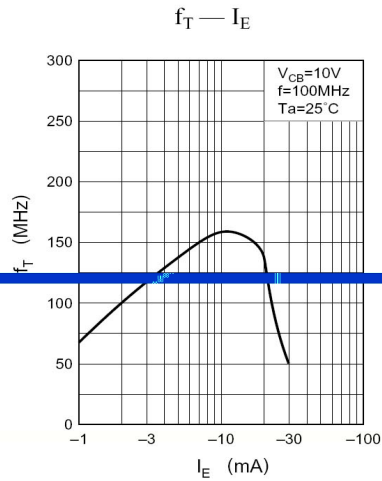
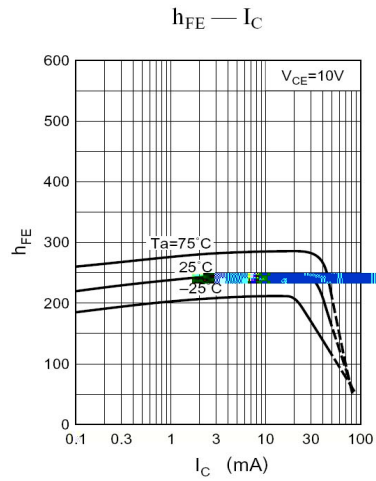
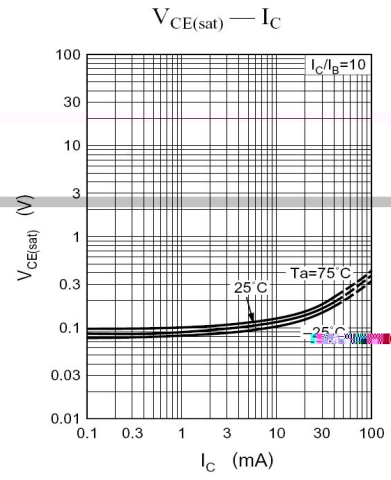
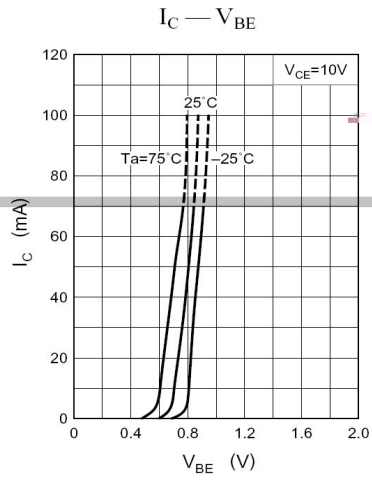
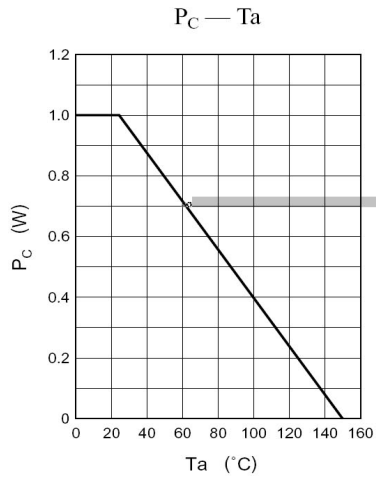

TO-92LM

Unit: mm

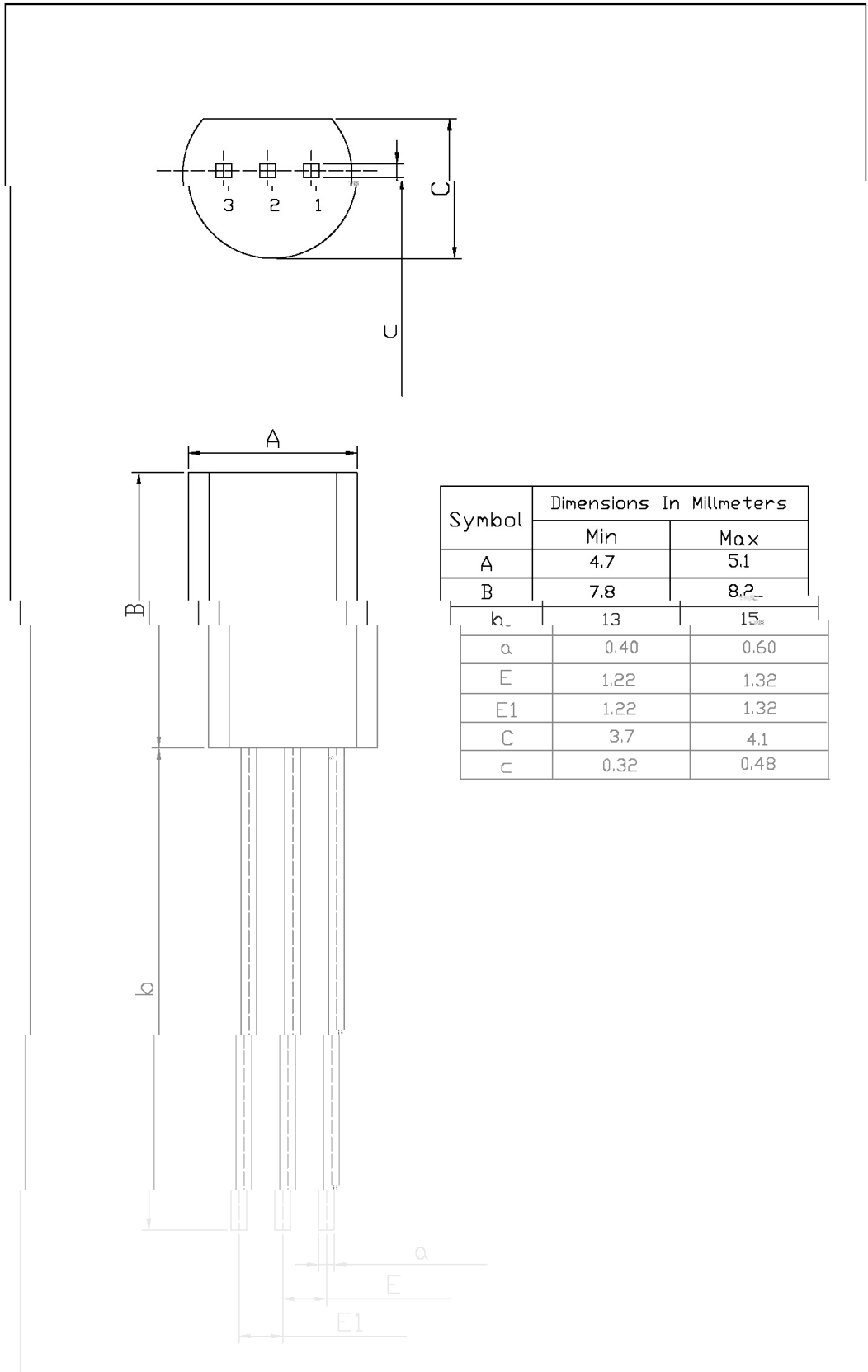

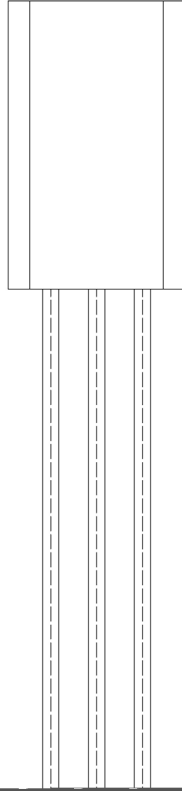

BR:

C2632

R:

h_{FE}
