

2SC2717

						μ

/ Electrical Characteristic Curve

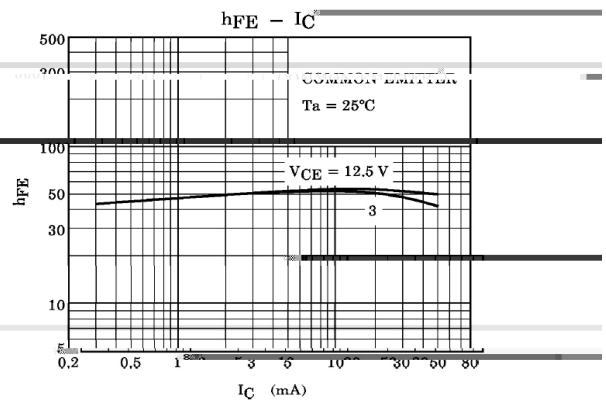
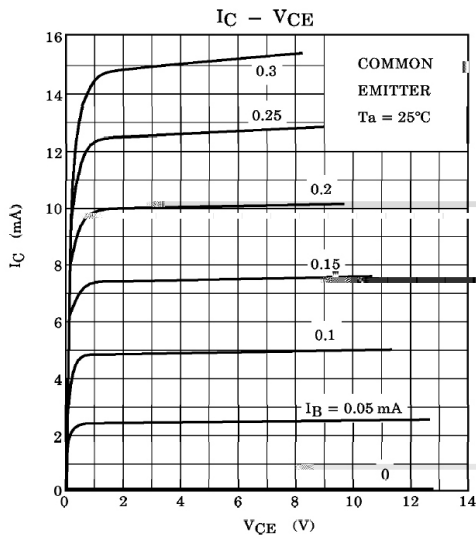
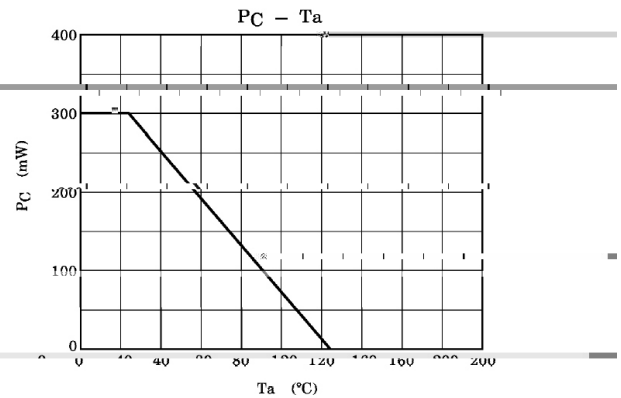
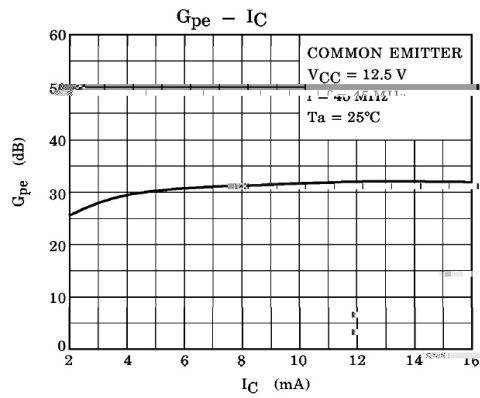
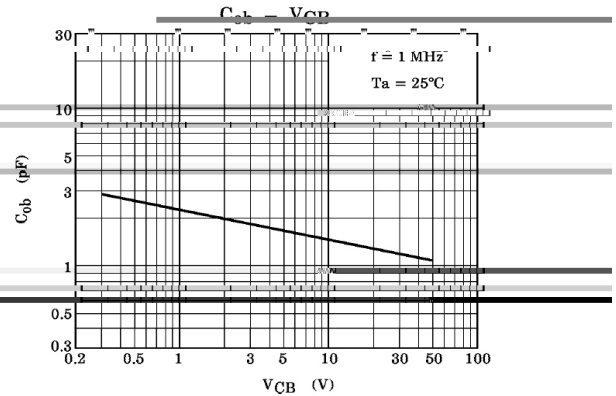
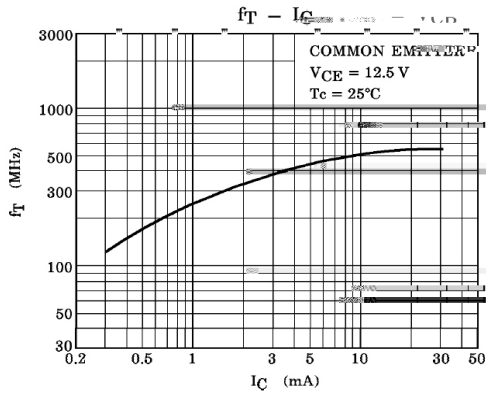

2SC2717

/ Package Dimensions

/ Marking Instructions

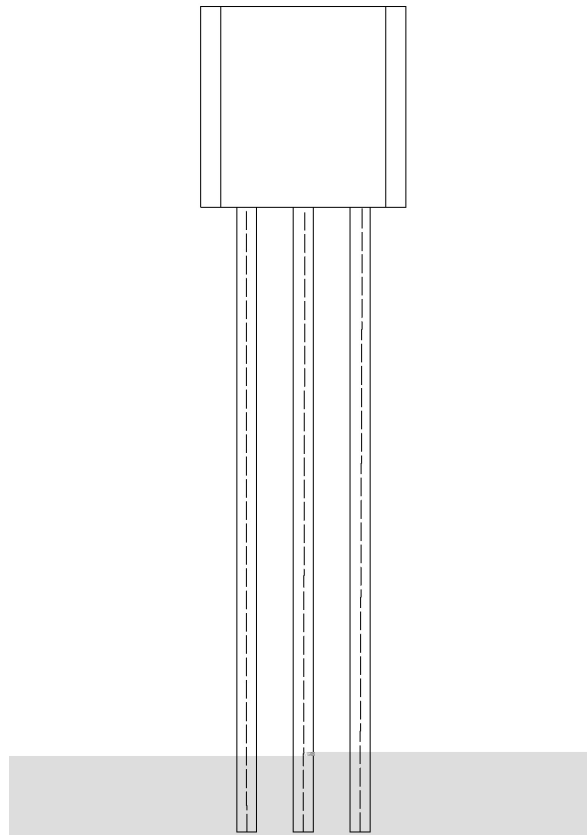

() / Temperature Profile for Dip Soldering(Pb-Free)

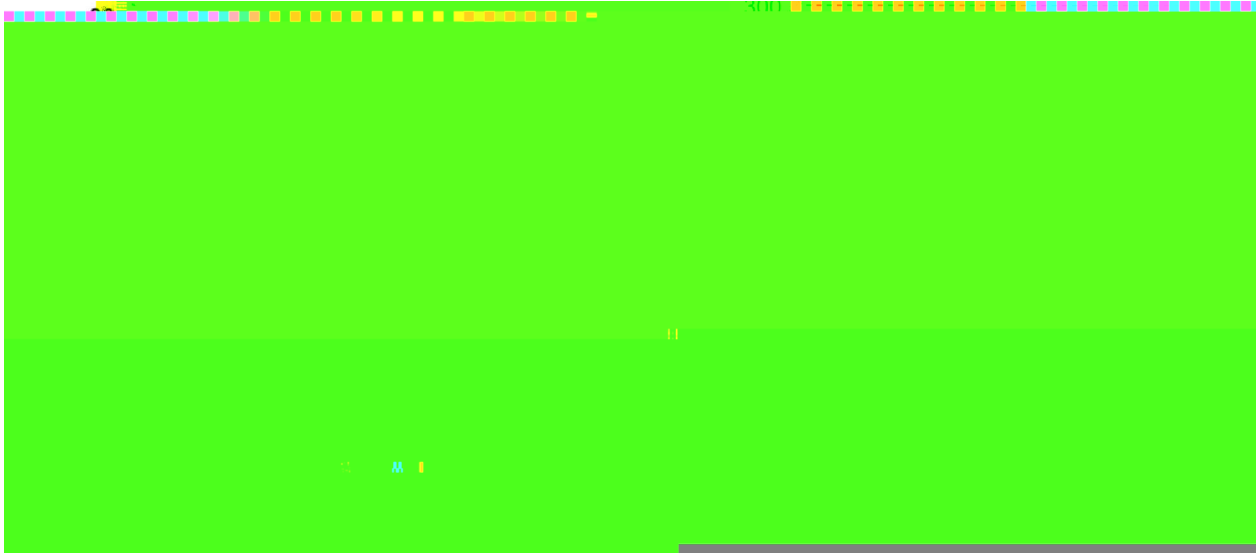

/ Resistance to Soldering Heat Test Conditions

/ Packaging SPEC.

封装形式	包装数量					包装尺寸 :		
	只袋	袋盒	只盒	盒箱	只箱	袋	盒	箱

封装形式	包装数量					包装尺寸 :	
	只纸带	纸带盒	纸带层盒	盒箱	只箱	盒	箱
						小箱	, 大箱

/ Notices