

/ Descriptions

/ Features

/ Applications

/ Equivalent Circuit

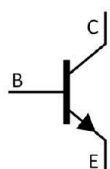

/ Pinning



/ hFE Classifications & Marking

/ Absolute Maximum Ratings(Ta=25)

			°C
			°C

/ Electrical Characteristics(Ta=25)

						μ
						μ

/ Electrical Characteristic Curve

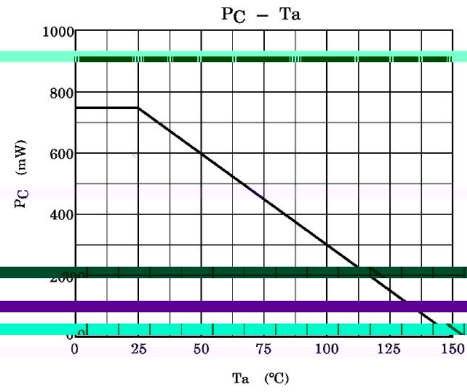
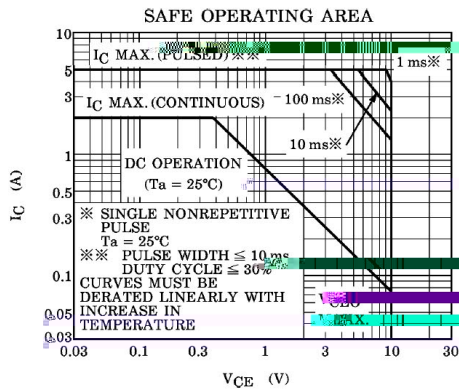
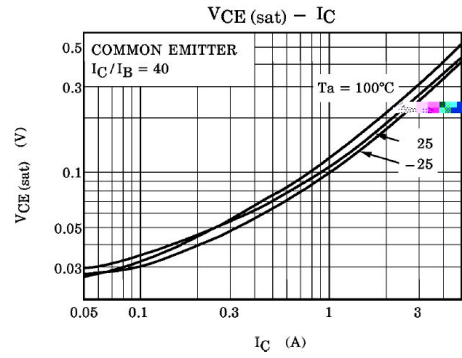
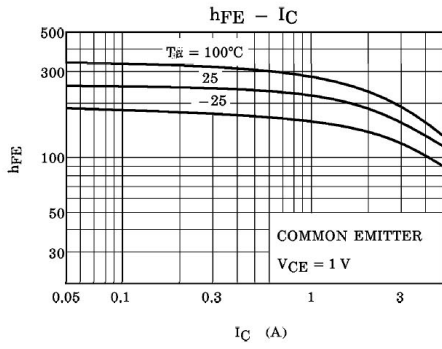
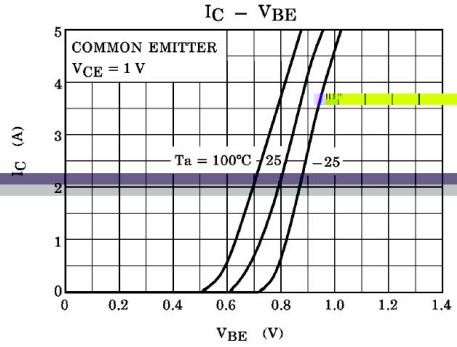
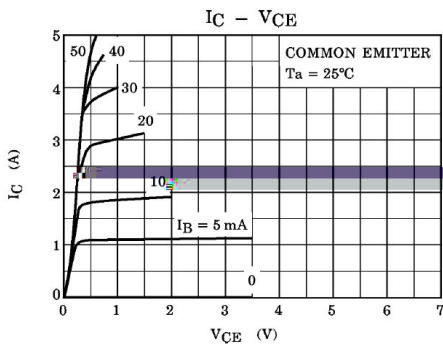

2SC3279

/ Package Dimensions

/ Marking Instructions

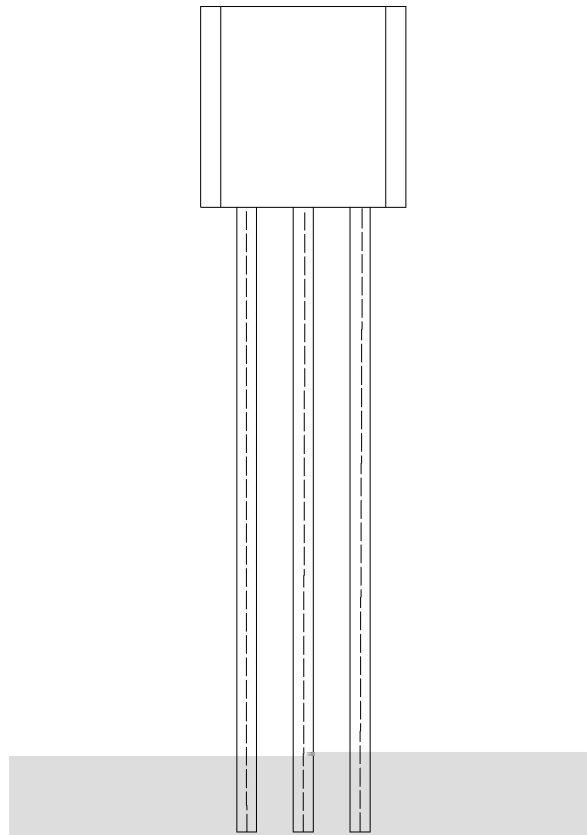

7
:

() / Temperature Profile for Dip Soldering(Pb-Free)



/ Resistance to Soldering Heat Test Conditions

± ± °C

/ Packaging SPEC.

封装形式	包装数量					包装尺寸 :		
	只袋	袋盒	只盒	盒箱	只箱	袋	盒	箱

封装形式	包装数量					包装尺寸 :	
	只纸带	纸带盒	纸带层盒	盒箱	只箱	盒	箱
							小箱 大箱 ,

/ Notices