

/ Descriptions

/ Features

/ Applications

/ Equivalent Circuit

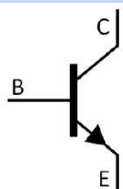

/ Pinning

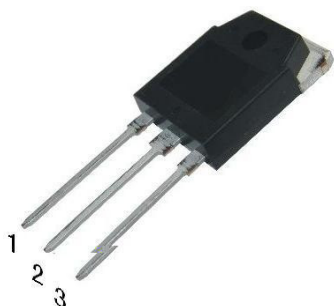

/ h_{FE} Classifications & Marking

/ Absolute Maximum Ratings(Ta=25)

		℃	
			℃
		~	℃

/ Electrical Characteristics(Ta=25)

/ Electrical Characteristic Curve

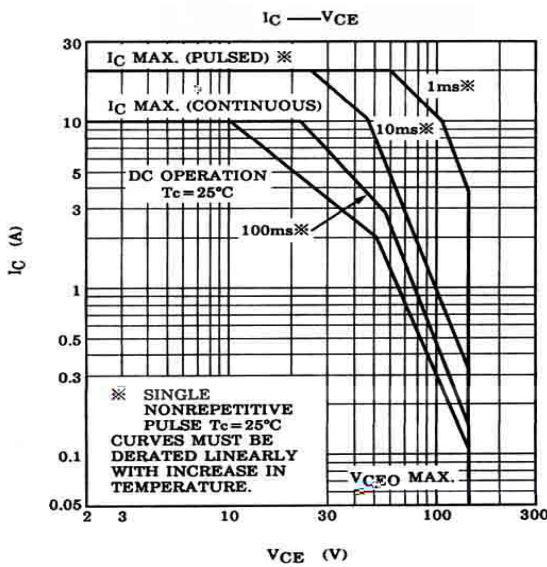
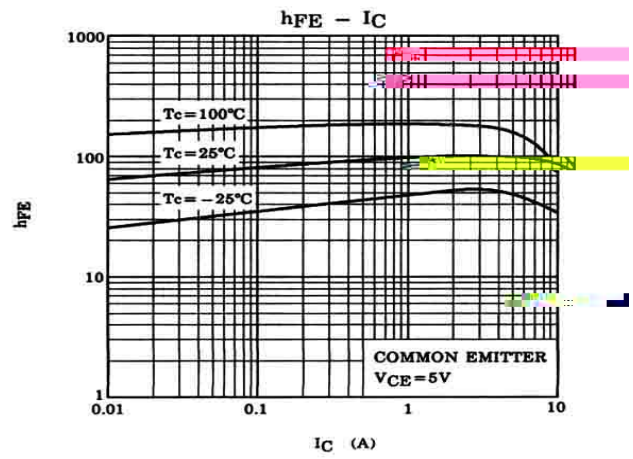
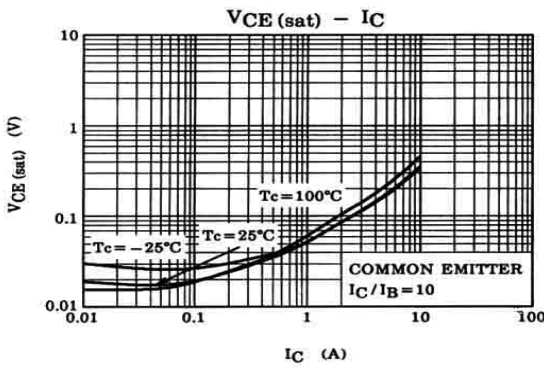
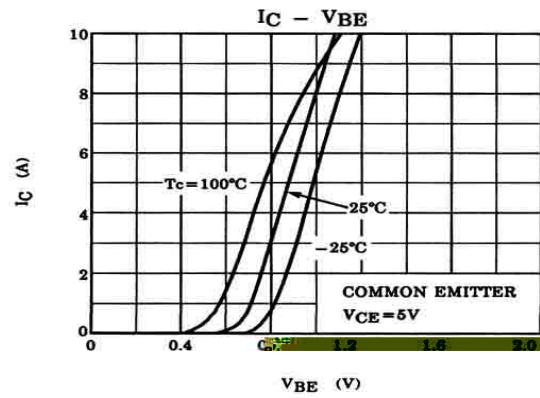
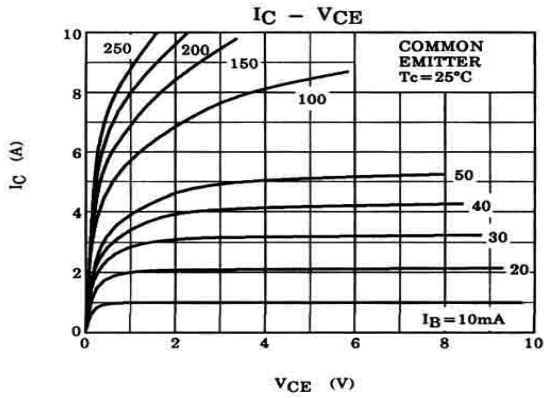

/ Package Dimensions

单位: mm

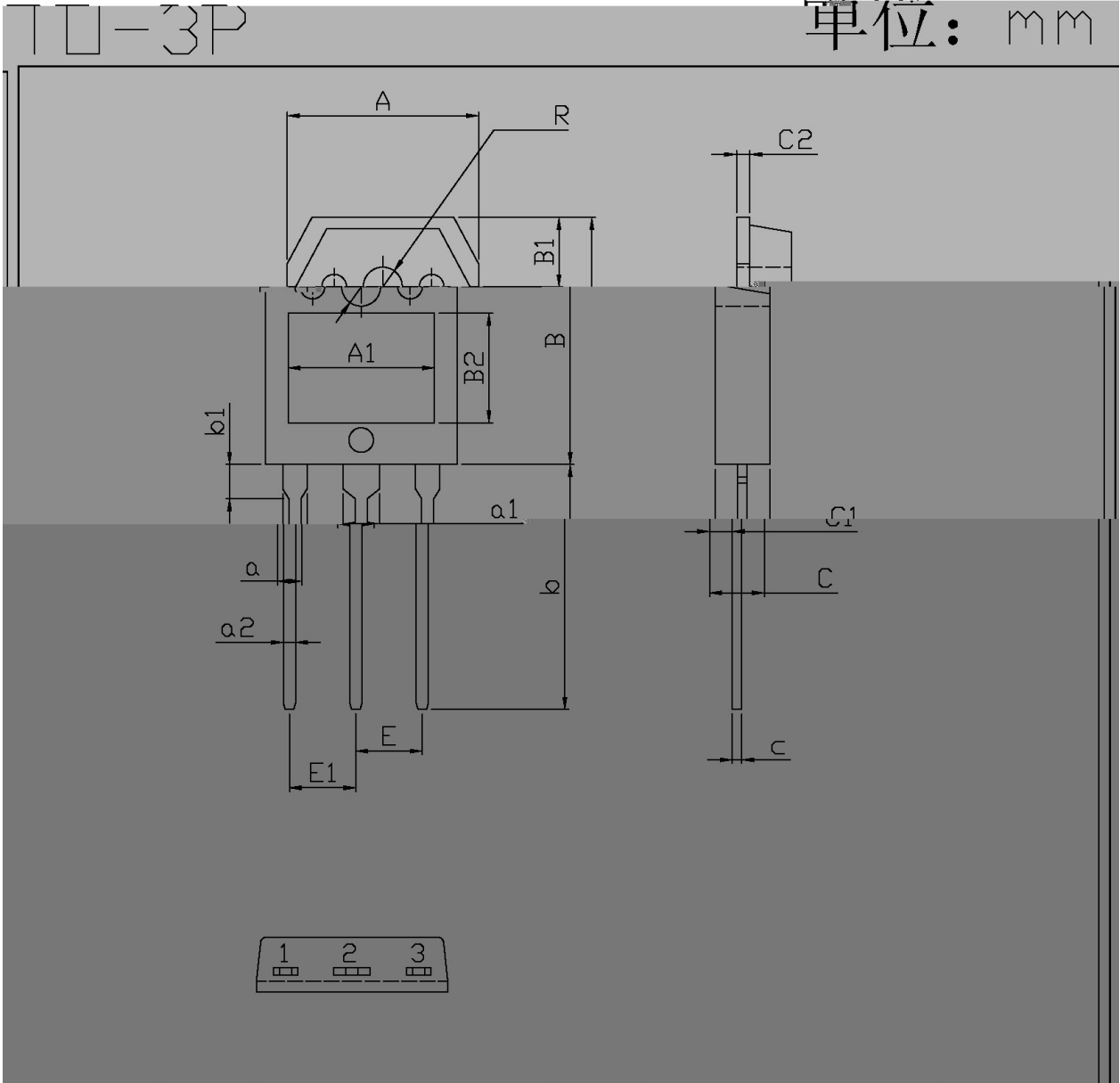

Dimensions in Millimeters

Symbol	Min	Max	Symbol	Min	Max
A1	12.0		C2	1.4	1.6
b	2.5	2.6	c	0.5	0.7
b1	3.0	3.4			
a	1.5	2.2			
a1	2.8	3.2			

() / Temperature Profile for Dip Soldering(Pb-Free)

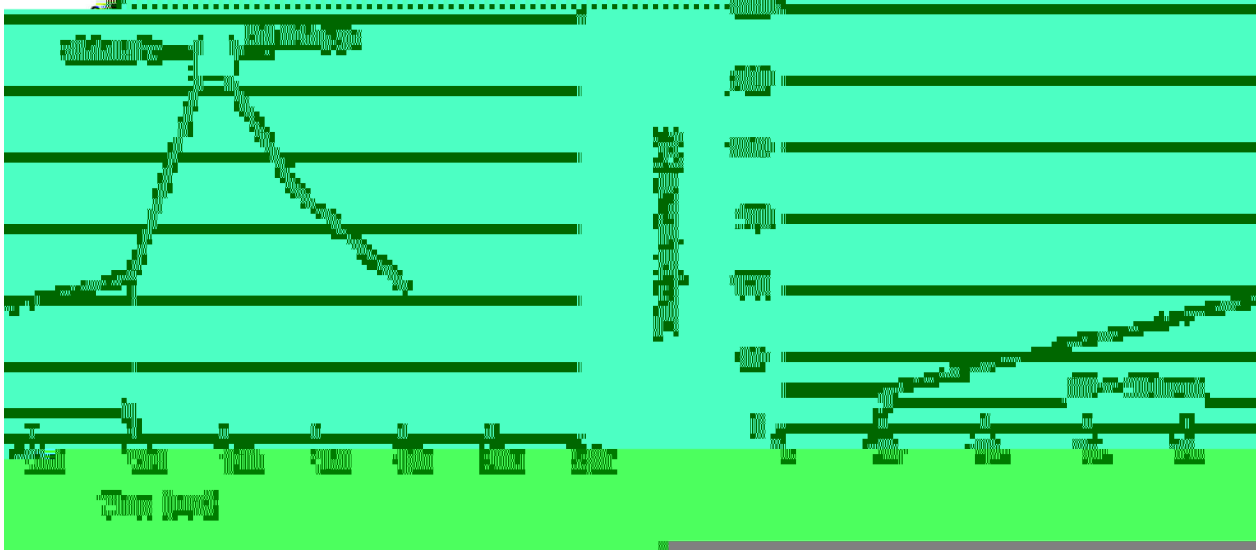

/ Resistance to Soldering Heat Test Conditions

°C

/ Packaging SPEC.

						Tube	Inner Box	Outer Box
	Units/Tube	Tubes/Inner Box	Units/Inner Box	Inner Boxes/Outer Box	Units/Outer Box			
TO-3P	30	15	450	5	2250	497.5×46×8	555×164×50	575×290×180

/ Notices