

Rev.F Apr.-2017

SOT-23

NPN

Silicon NPN transistor in a SOT-23 Plastic Package.

Large current capacity ,low  $V_{CE\ sat}$  ,wide ASO.

Audio frequency amplifier, medium-speed switching, small-sized motor drivers.

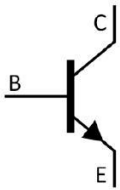

PIN1 Base

PIN 2 Emitter

PIN 3 Collector

Parameter	Symbol	Rating	Unit
Collector to Base Voltage	$V_{CBO}$	15	V
Collector to Emitter Voltage	$V_{CEO}$	15	V
Emitter to Base Voltage	$V_{EBO}$	5.0	V
Collector Current	$I_C$	0.8	A
Collector Current(Pulse)	$I_{CP}$	3.0	A
Collector Power Dissipation	$P_C$	250	mW
Junction Temperature	$T_j$	150	
Storage Temperature Range	$T_{stg}$	-55 150	

BT74802 527.3 08

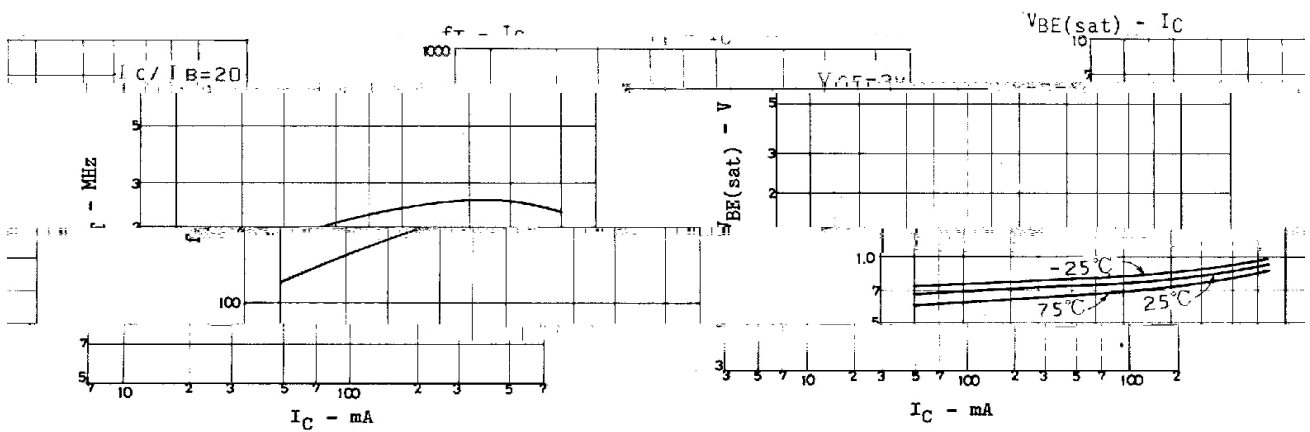
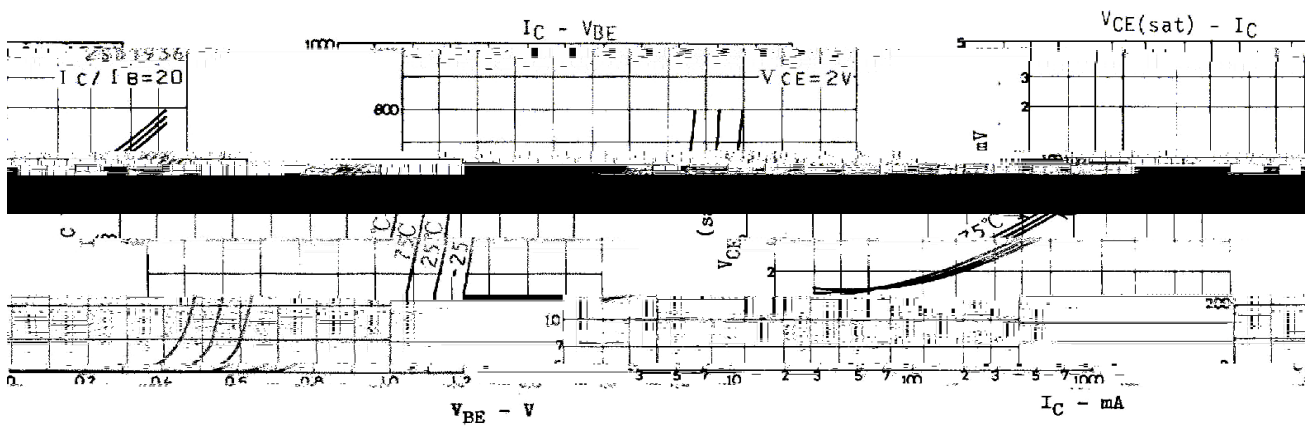
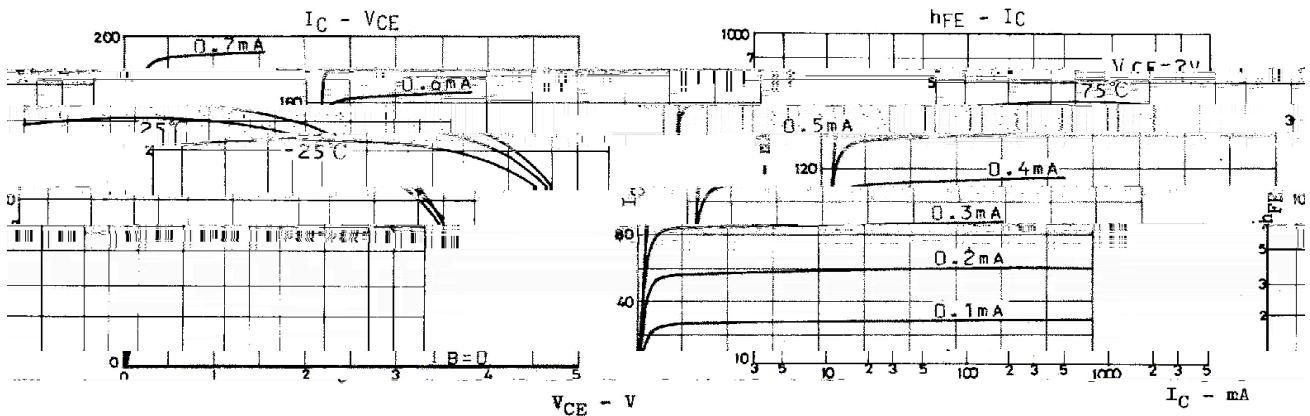

SOT-23

单位; mm

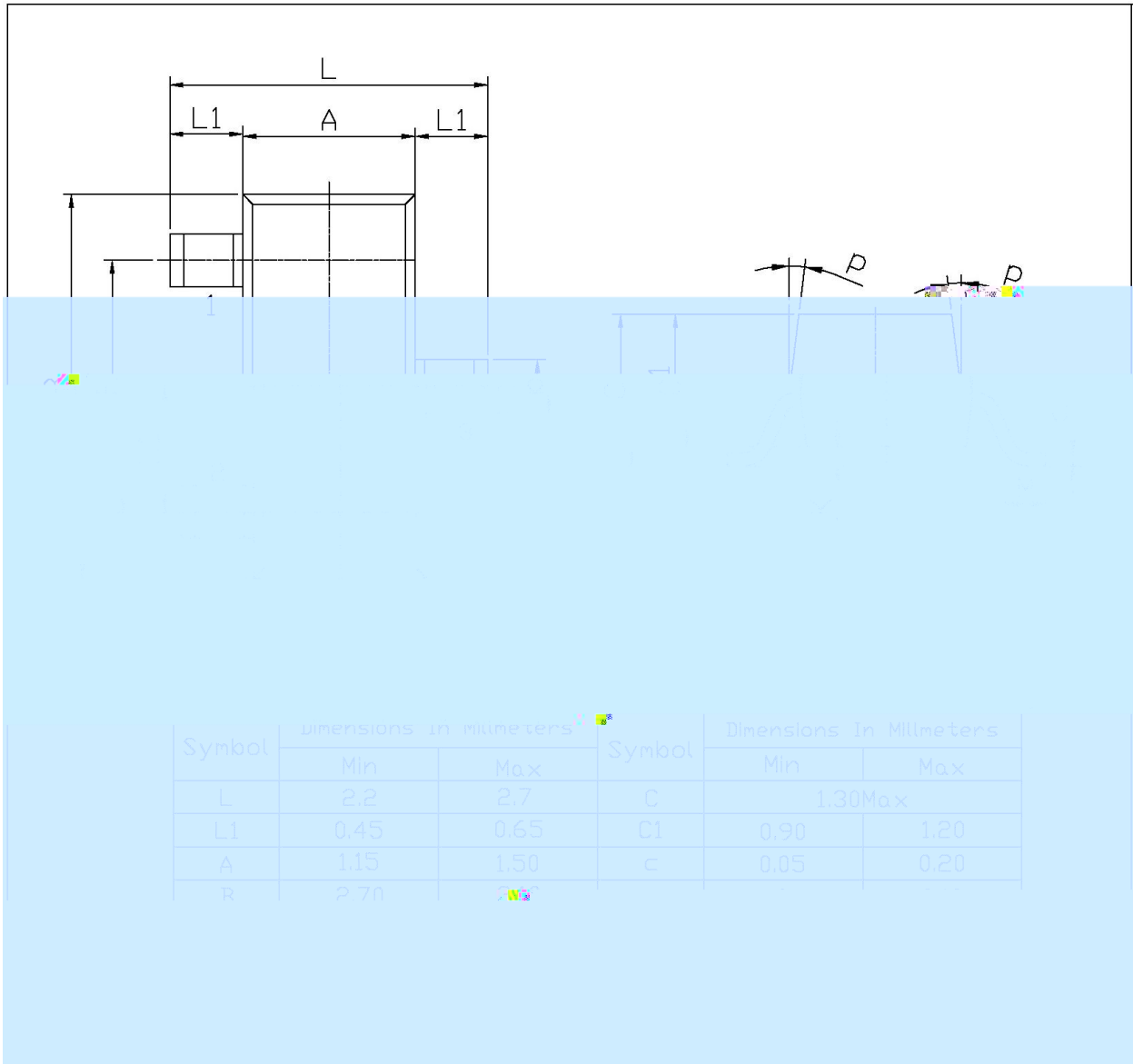

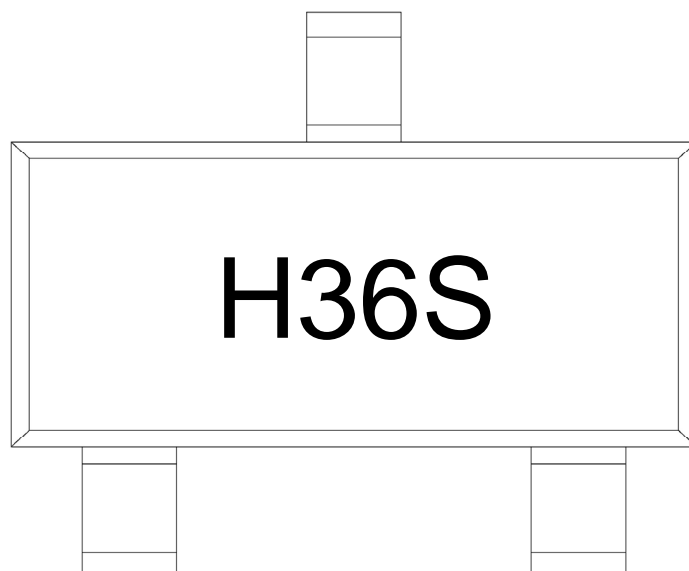

H  
36  
S:           h<sub>FE</sub>  
Note:  
H:           Company Code  
36:          Product Type Code  
S:           h<sub>FE</sub> Classifications Symbol Code

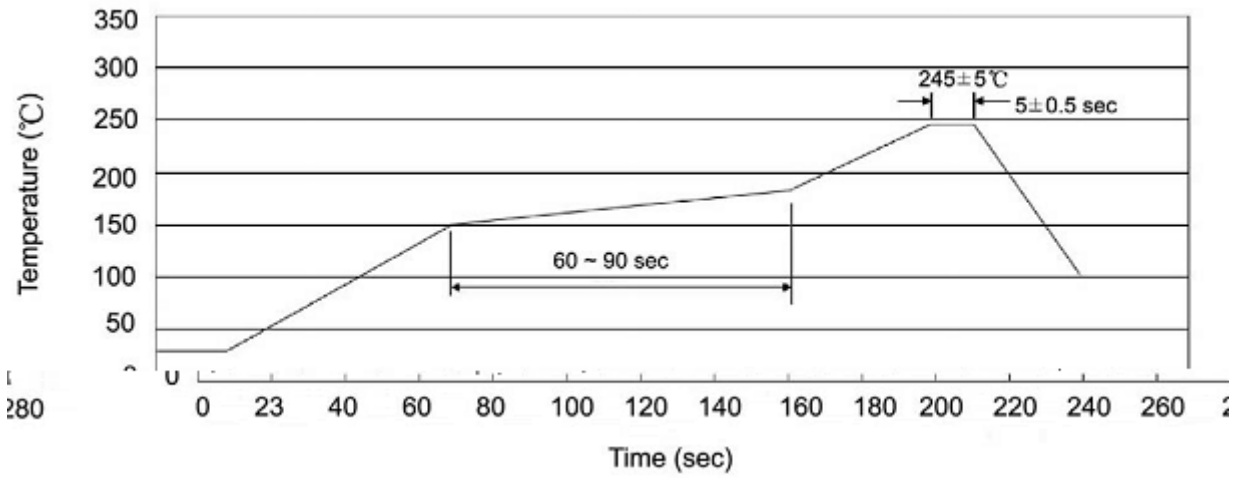

Note:

- |   |        |           |                     |
|---|--------|-----------|---------------------|
| 1 | 25 150 | 60 90sec; | 1.Preheating:25~150 |
|---|--------|-----------|---------------------|