

78D05

Rev.J Jun.-2024

/ Descriptions

TO-252 Voltage Regulator in a TO-252 Plastic Package.

/ Features

1.5A,
3-Terminal regulators ,output current up to 1.5A, internal thermal overload protection and short-circuit limiting, HF Product.

/ Applications

Voltage Regulator.

/ Equivalent Circuit or Application Circuit

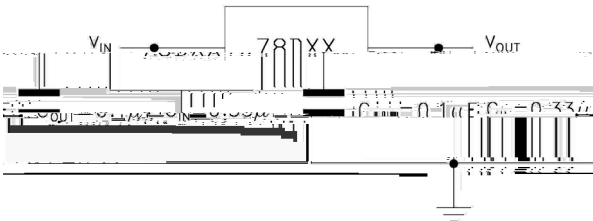

/ Pinning

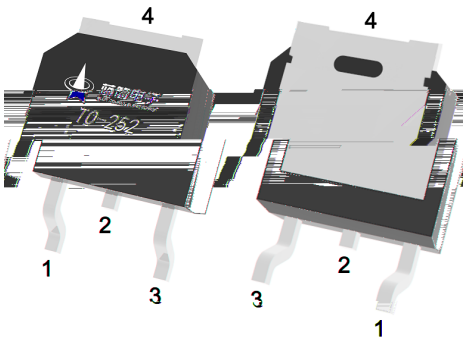

PIN1 IN PIN 2 4 GND PIN 3 OUT

/ Marking

See Marking Instructions.

Parameter

/ Electrical Characteristic Curve

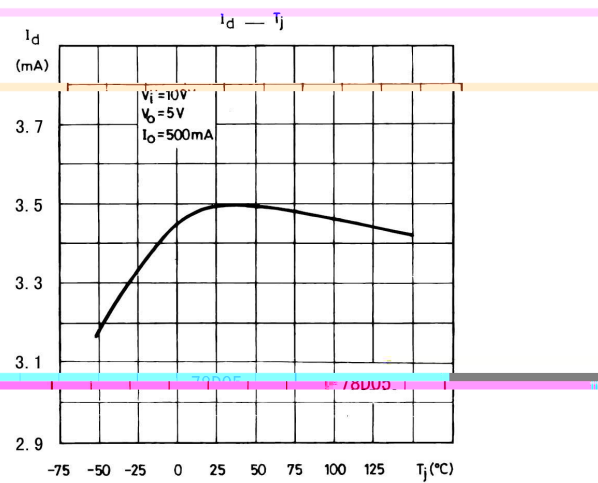
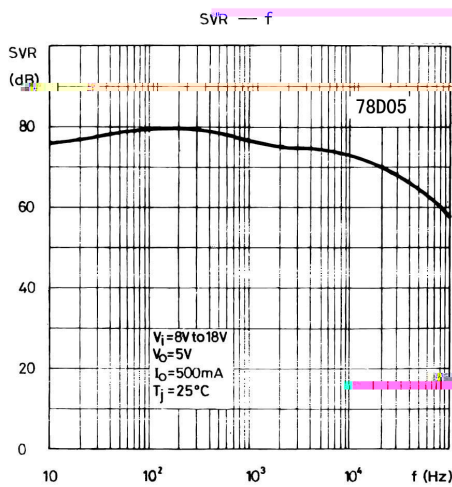
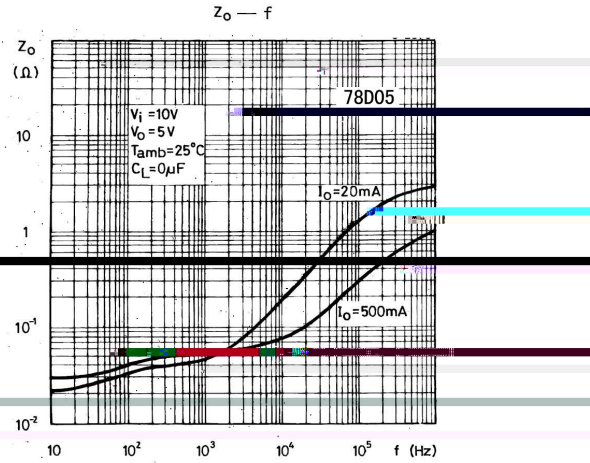
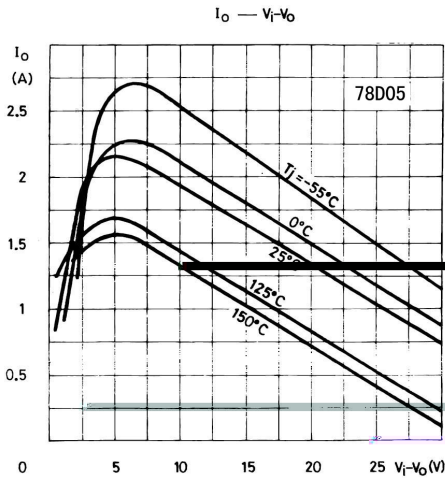
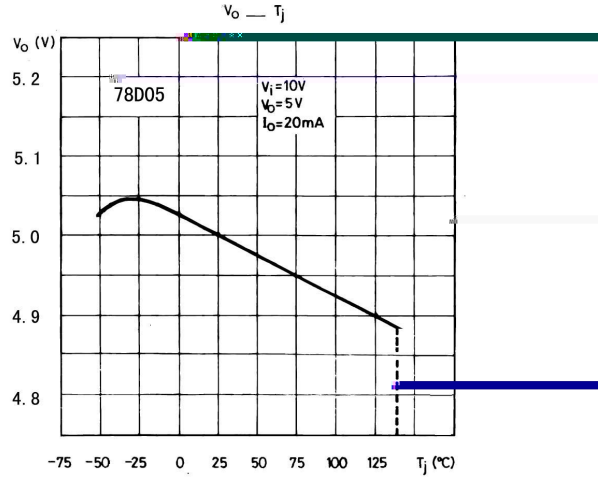
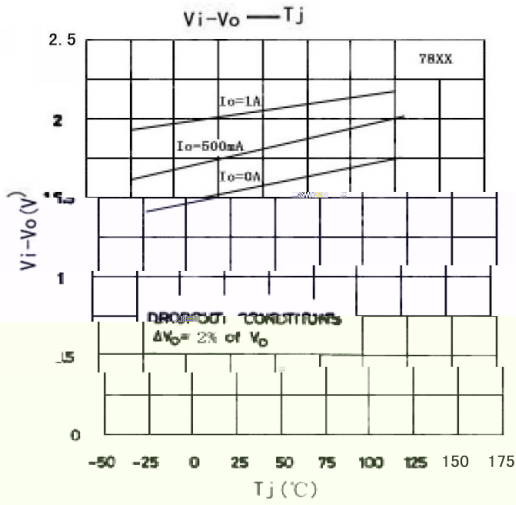

/ Package Dimensions

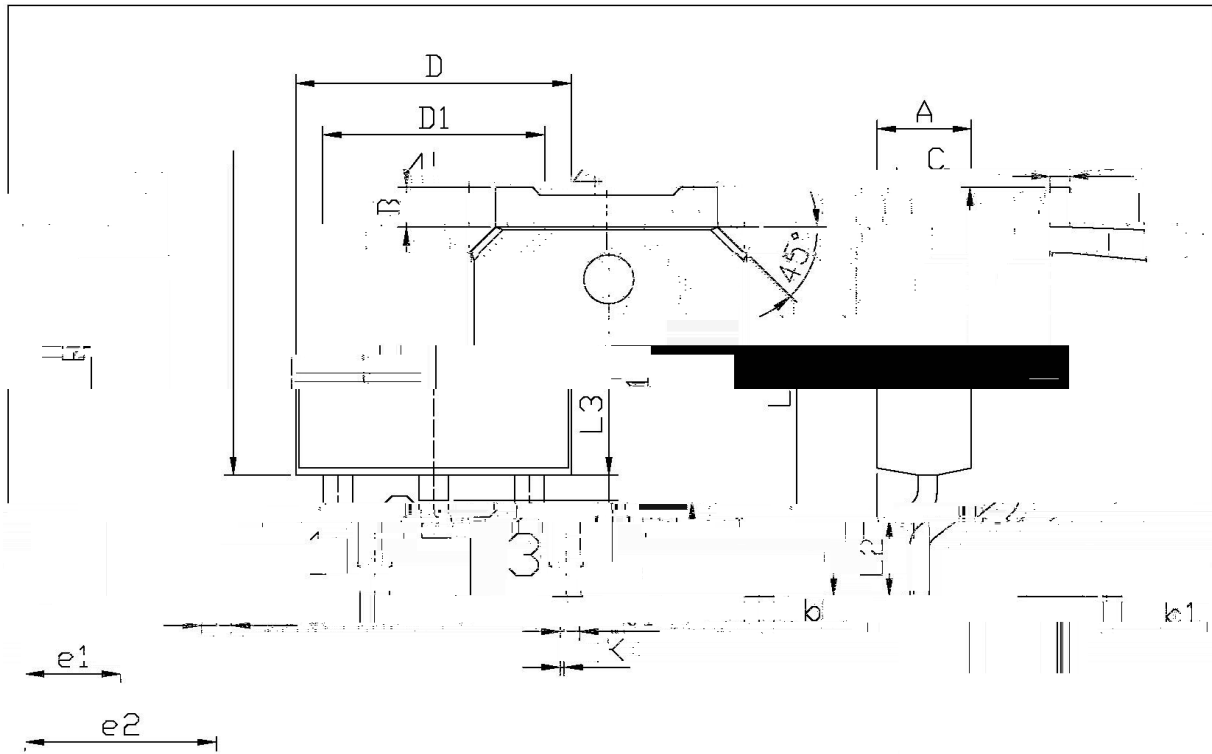

单位: mm

Symbol	Dimensions In Millimeters		Symbol	Dimensions In Millimeters	
	Min	Max		Min	Max
A	6.25		A	2.40	2.40
B	2.34		B	1.25	1.25
C	9.85	10.35	C	0.70	0.80
D	0.60	0.90	D	1.70	2.00
e1	2.54		e1	0.45	0.55
e2	2.54		L1	0.55	0.55
L1	0.60	0.90	L2	0.70	0.80
L2	0.60	0.90	L3	0.45	0.55

J-252

TL

78D05

Rev.J Jun.-2024

() / Temperature Profile for IR Reflow Soldering(Pb-Free)

Note:

- 1 150 180 60 90sec; 1.Preheating:150~180 , Time:60~90sec.
- 2 245±5 5±0.5sec; 2.Peak Temp.:245±5 , Duration:5±0.5sec.
- 3 2 10 /sec. 3. Cooling Speed: 2~10 /sec.

/ Resistance to Soldering Heat Test Conditions

260±5 10±1 sec. Temp.:260±5 Time:10±1 sec

/ Packaging SPEC.

/ REEL

Package Type	Units			Dimension (unit mm ³)		
	Units	Dimension	Dimension	mm	mm	mm