

BC338

Rev.E Mar.-2016

/ Descriptions

TO-92(R) NPN Silicon NPN transistor in a TO-92(R) Plastic Package.

/ Features

BC328
High current, complementary pair with BC328.

/ Applications

General purpose and switching.

/ Equivalent Circuit

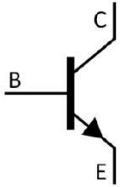

/ Pinning



PIN1 Emitter PIN 2 Base PIN 3 Collector

/ h_{FE} Classifications & Marking

h_{FE} Classifications Symbol	16	25	40
h_{FE} Range	100~250	160~400	250~600

/ Absolute Maximum Ratings(Ta=25)

Parameter	Symbol	Rating	Unit
Collector to Base Voltage	V_{CBO}	30	V
Collector to Emitter Voltage	V_{CEO}	25	V
Emitter to Base Voltage	V_{EBO}	5.0	V
Collector Current - Continuous	I_C	800	mA
Emitter Current - Continuous	I_E	-800	mA
Collector Power Dissipation	P_C	625	mW
Junction Temperature	T_j	150	
Storage Temperature Range	T_{stg}	-55~150	

/ Electrical Characteristics(Ta=25)

Parameter	Symbol	Test Conditions	Min	Typ	Max	Unit
Collector Cut-Off Current	I_{CBO}	$V_{CB}=25V$ $I_E=0$			0.1	μA
DC Current Gain	h_{FE}	$V_{CE}=1.0V$ $I_C=100mA$	100		600	
Collector to Emitter Saturation Voltage	$V_{CE(sat)}$	$I_C=500mA$ $I_B=50mA$			0.7	V
Base to Emitter On Voltage	$V_{BE(ON)}$	$V_{CE}=1.0V$ $I_C=300mA$			1.2	V
Transition Frequency	f_T	$V_{CE}=5.0V$ $I_C=10mA$ $f=100MHz$		100		MHz
Collector output capacitance	C_c	$V_{CB}=10V$ $f=1.0MHz$		12		pF

/ Electrical Characteristic Curve

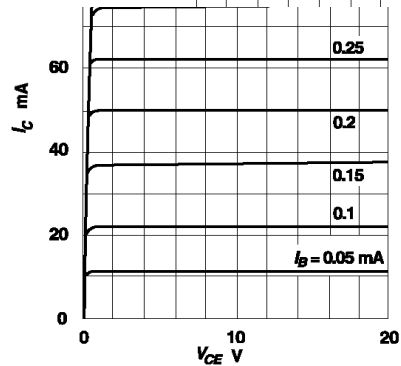
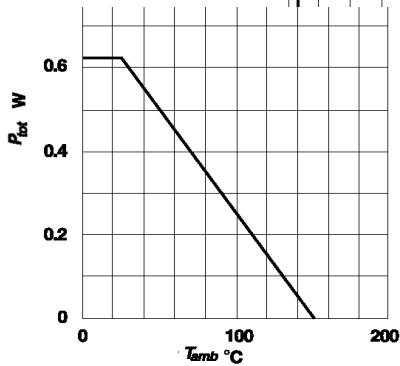
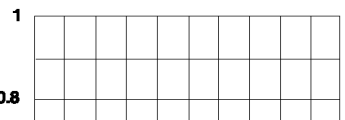
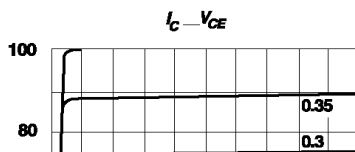
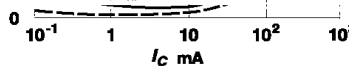
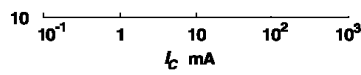
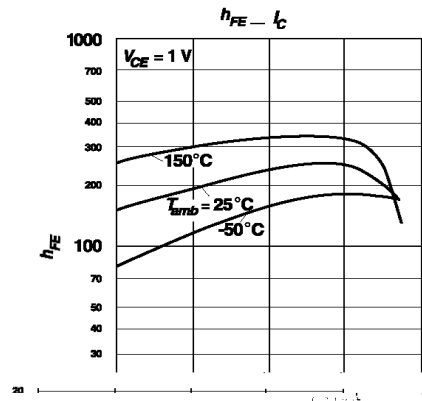
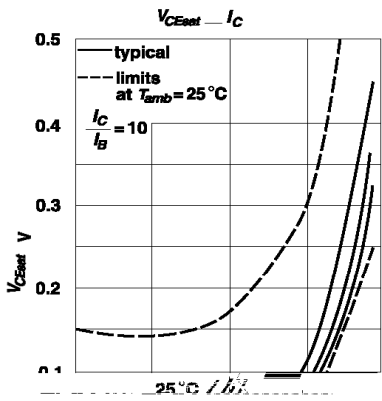
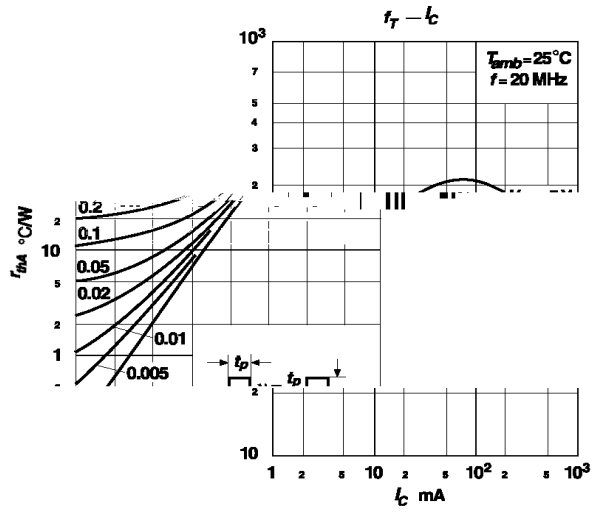
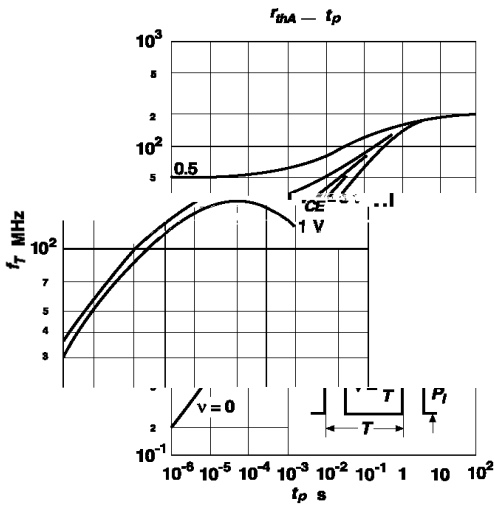

/ Package Dimensions

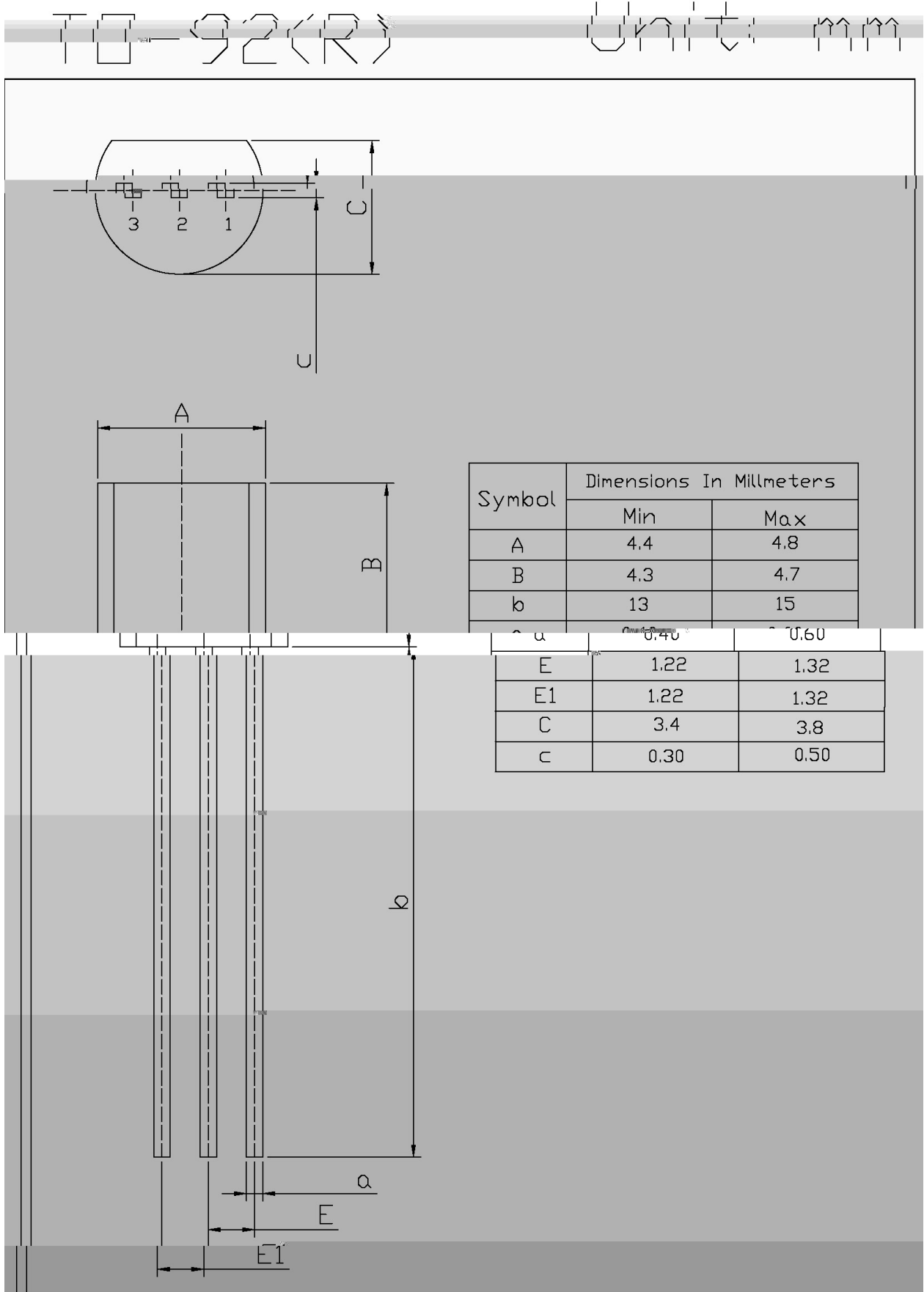

/ Marking Instructions

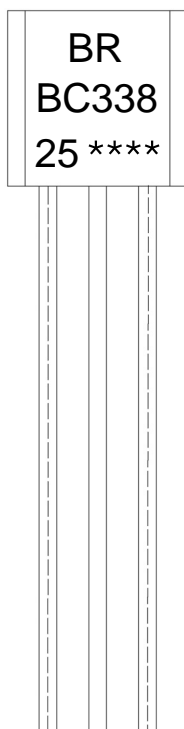

BR

BC338

25: h_{FE}

Note:

BR: Company Code.

BC338: Product Type.

25: h_{FE} Classifications Symbol

****: Lot No. Code, code change with Lot No.

() / Temperature Profile for Dip Soldering(Pb-Free)

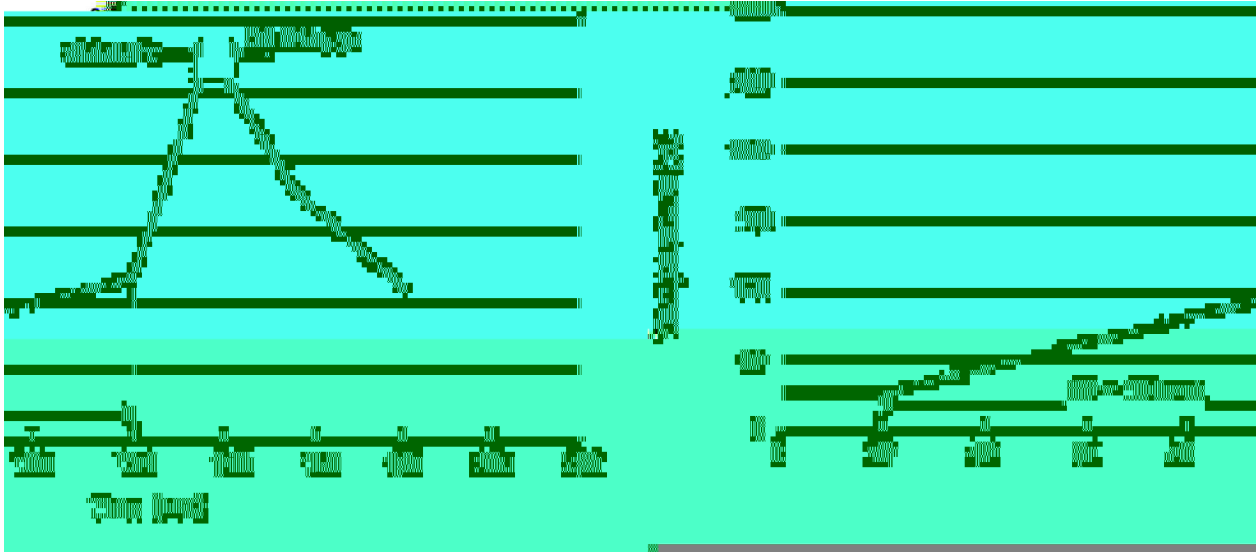

- 1 25 150 60 90sec;
- 2 255±5 5±0.5sec;
- 3 2 10 /sec.

Note:

- 1.Preheating:25~150 , Time:60~90sec.
- 2.Peak Temp.:255±5 , Duration:5±0.5sec.
- 3. Cooling Speed: 2~10 /sec.

/ Resistance to Soldering Heat Test Conditions

270±5 10±1 sec. Temp.:270±5 Time:10±1 sec

/ Packaging SPEC.

/ BULK

Package Type	Units					Dimension (unit mm3)		
	Units/Bag /	Bags/Inner Box /	Units/Inner Box /	Inner Boxes/Outer Box /	Units/Outer Box /	Bag	Inner Box	Outer Box
TO-92	1,000	10	10,000	5	50,000	135×190	237×172×102	560×245×195
	1,000	10	10,000	10	100,000	135×190	237×172×102	560×245×375

/ AMMO

Package Type	Units					Dimension (unit mm3)	
	Units/tape /	Tape/Inner Box /	Rows/Inner Box /	Inner Boxes/Outer Box /	Units/Outer Box /	Inner Box	Outer Box
TO-92	3,000	1	120	10	30,000	328×230×42	480×346×235 547×407×268

/ Notices