

**/ Descriptions**

**/ Features**

**/ Applications**

DC/DC

**/ Equivalent Circuit**

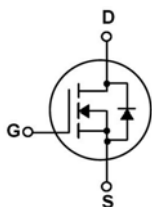

**/ Pinning**

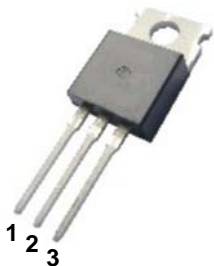

**/ h<sub>FE</sub> Classifications & Marking**

**/ Absolute Maximum Ratings(Ta=25 )**

		°C	
		°C	
			°C

**/ Electrical Characteristics(Ta=25 )**

			μ			
						μ
						μ
			μ			
						Ω
						Ω
			Ω			

/ Electrical Characteristic Curve

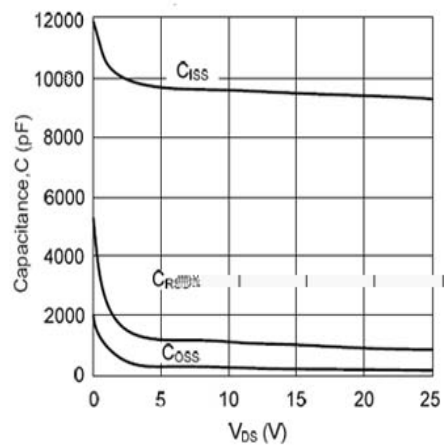
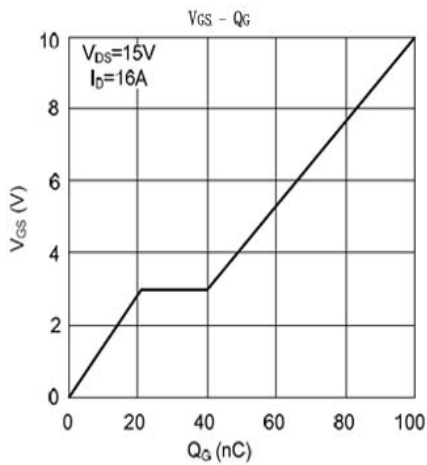
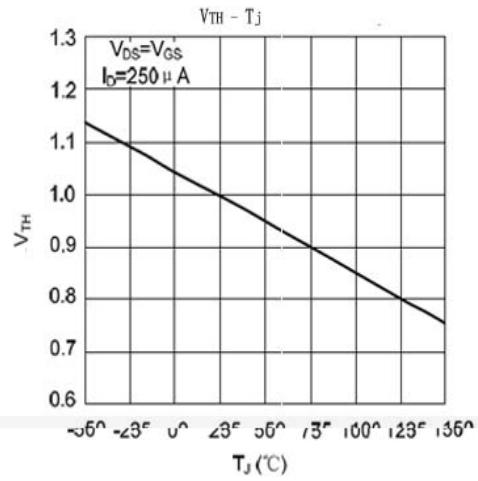
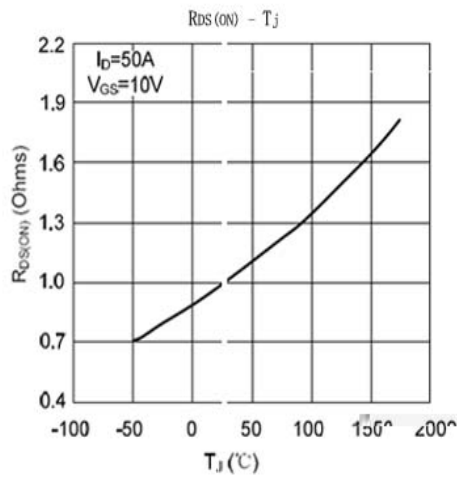
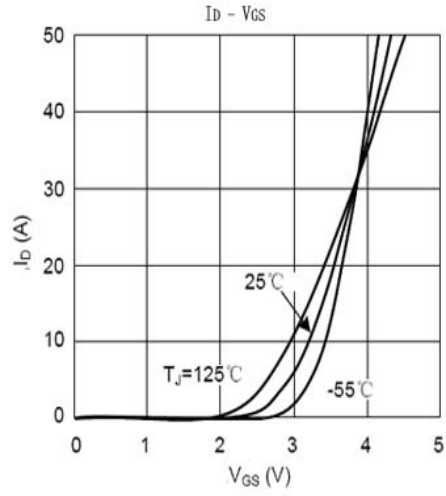
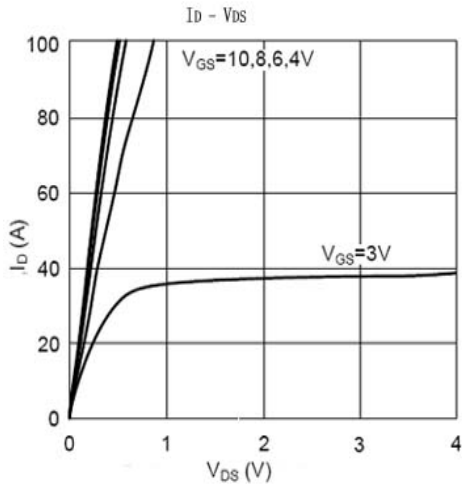

/ Package Dimensions

TO-220

单位: mm

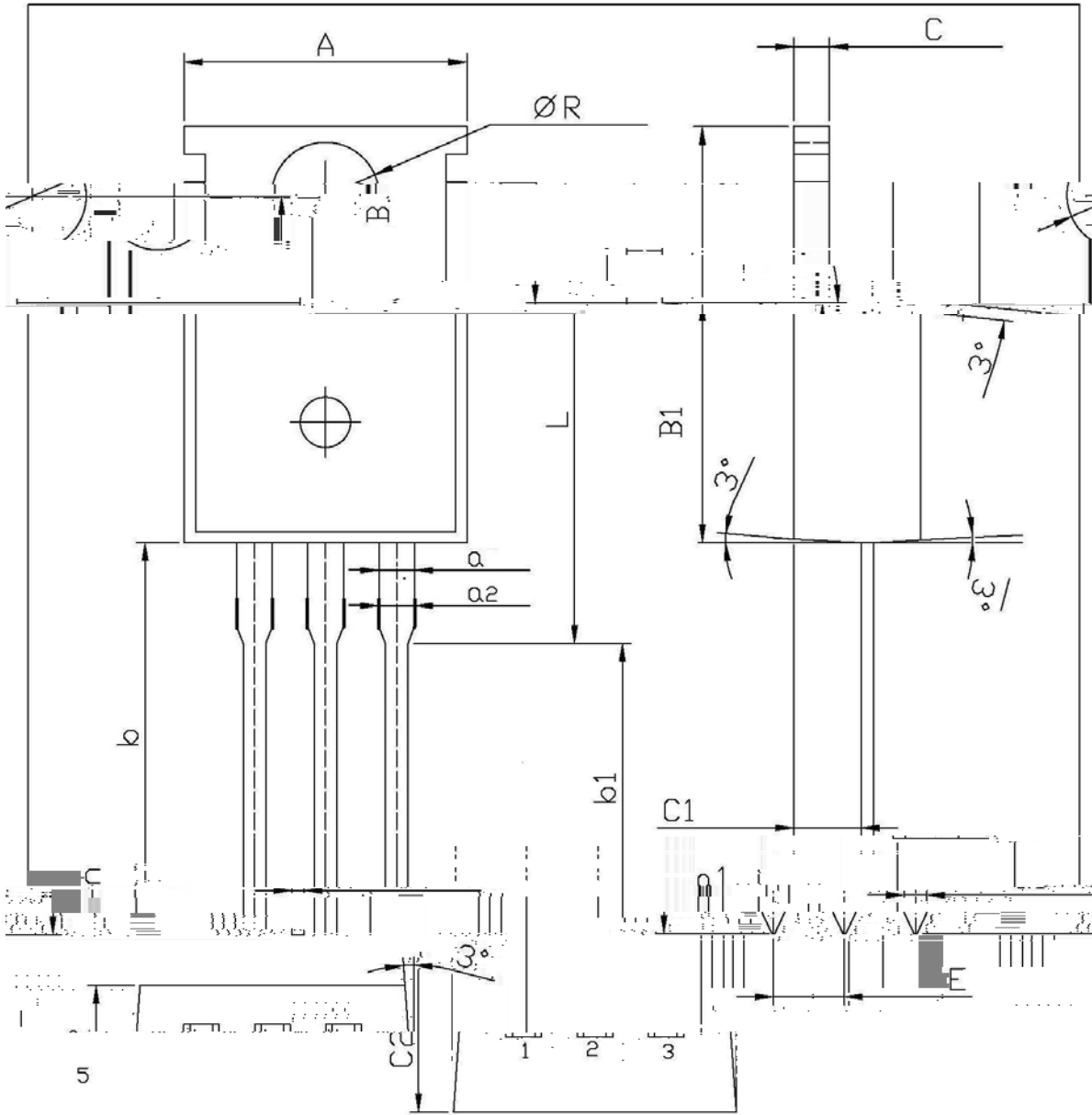

Symbol	Dimensions In Millimeters		Symbol	Dimensions In Millimeters	
	Min	Max		Min	Max
1.4		9.8	C	10.2	12
6.7		3.56	B	3.64	6.3
9.4		15.7	B1	16.1	19.0
2.6		12.6	C1	13.6	2.2
0.9		9.6	a1	10.6	0.7
0.6		1.22	c	1.32	0.4
1.7		3.34	C3	3.71	4.3
0.2	1.25	1.45			

/ Marking Instructions

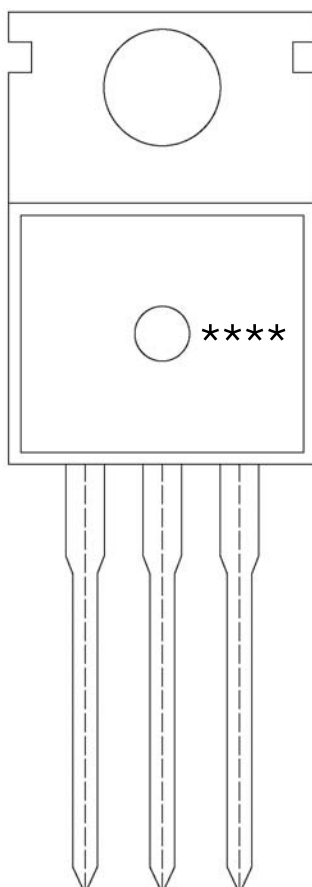

100N03

\*\*\*\*

