

1.5A,

AEC-Q100

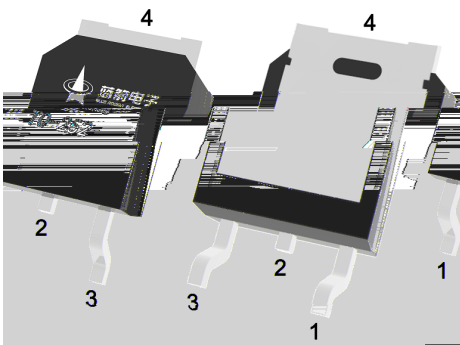

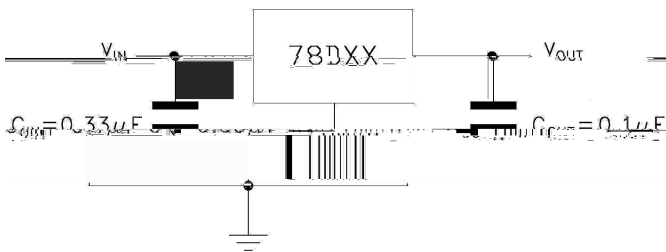

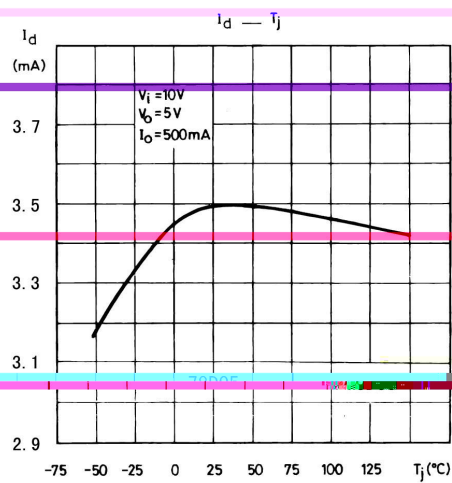
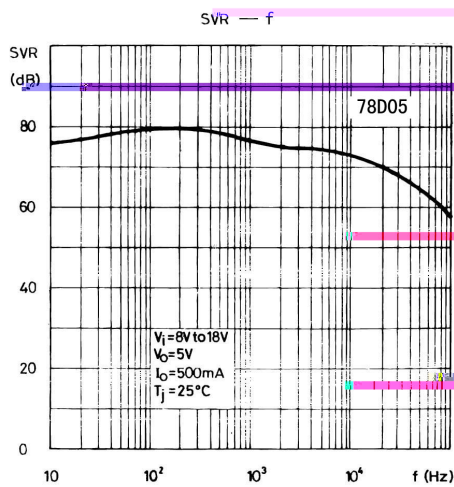
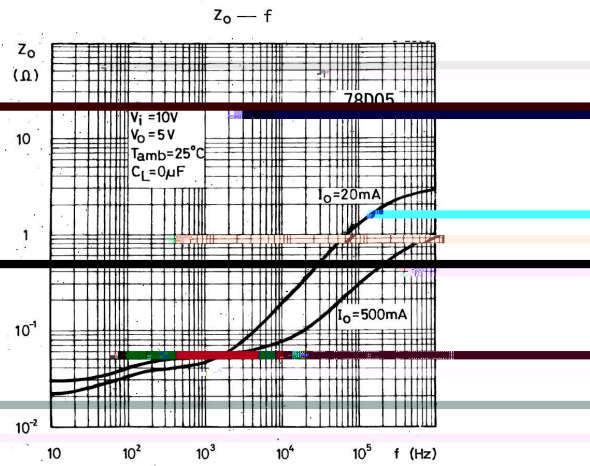
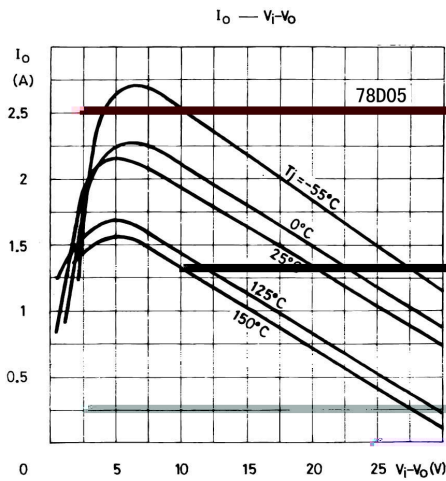
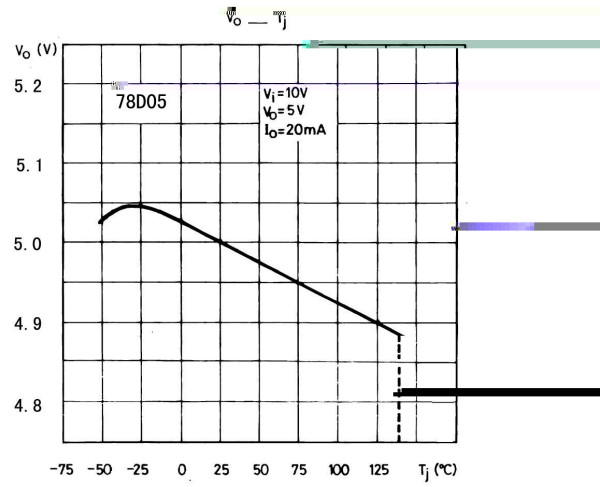
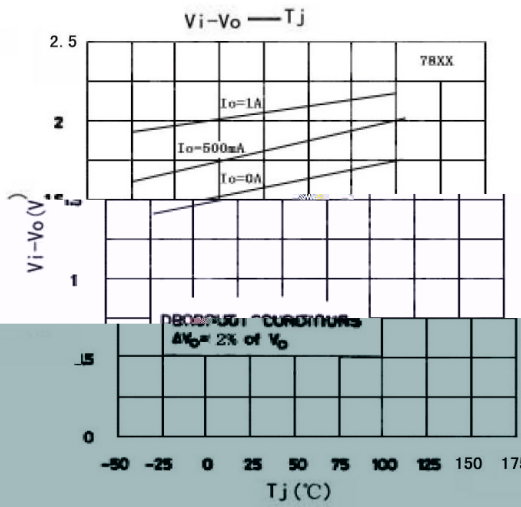
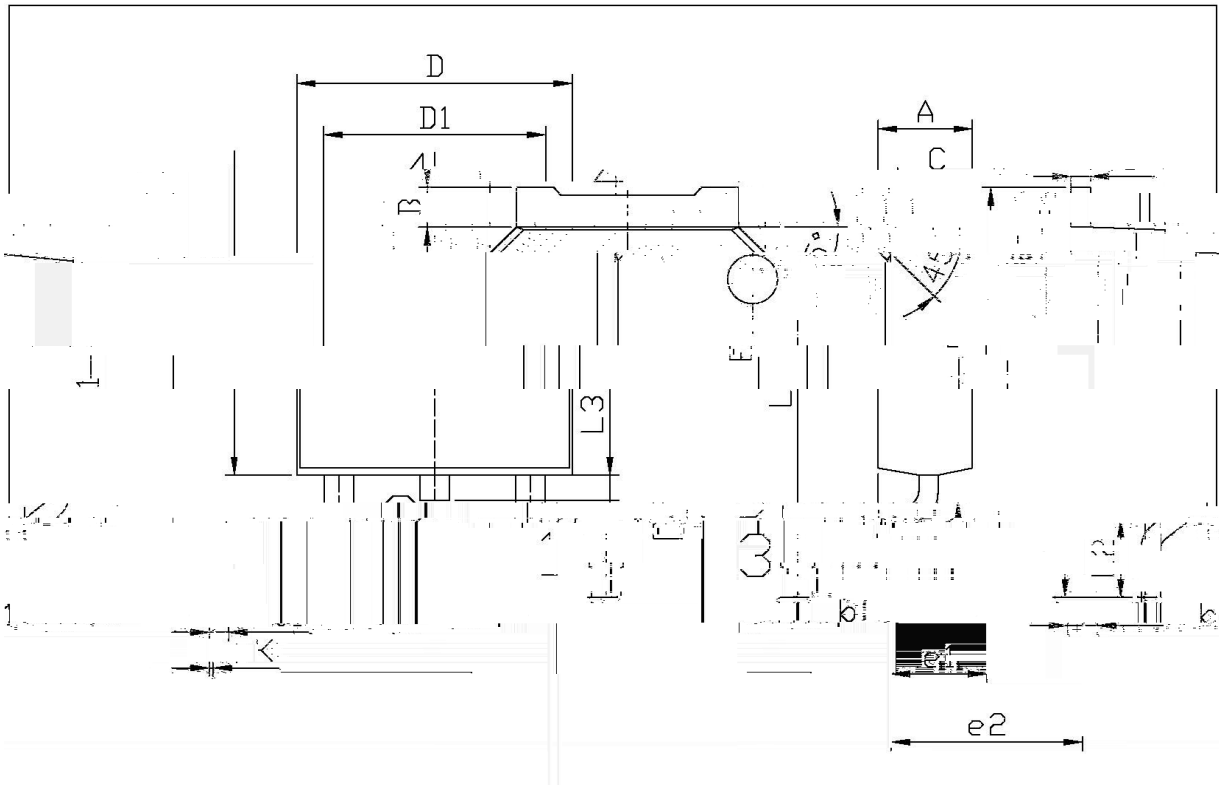

单位: mm

Symbol	Dimensions In Millimeters		Symbol	Dimensions In Millimeters	
	Min	Max		Min	Max
E	5.95	6.25	A	2.20	2.40
e1	2.24	2.34	B	0.95	1.25
L3	4.43	4.73	e	0.30	0.60
L	9.85	10.35	b1	0.45	0.55
L1	2.45	2.55	L2	1.70	2.00
L2	0.60	0.90	D	6.45	6.75
L3	0.60	0.90	D1	5.10	5.50

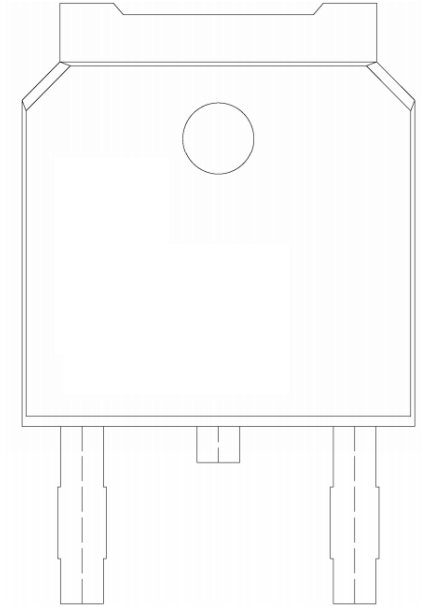

BR

78D05

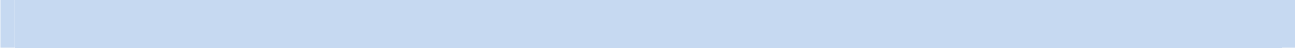

±

±

±

±



±

±

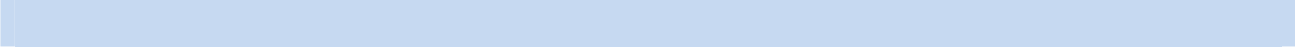

	Units/Reel /	Reels/Inner Box /	Units/Inner Box /	Inner Boxes/Outer Box /	Units/Outer Box /	Reel	Inner Box	Outer Box
--	-----------------	----------------------	----------------------	----------------------------	----------------------	------	-----------	-----------