

DC/DC

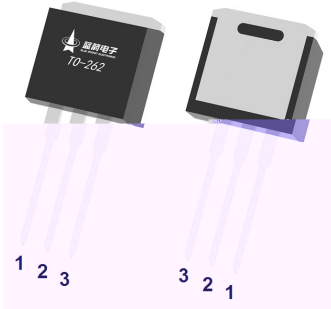

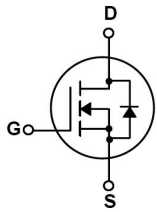

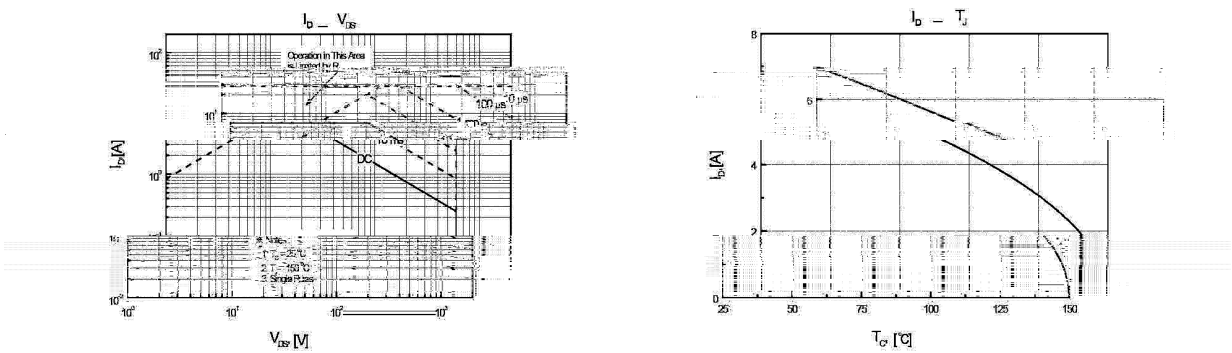
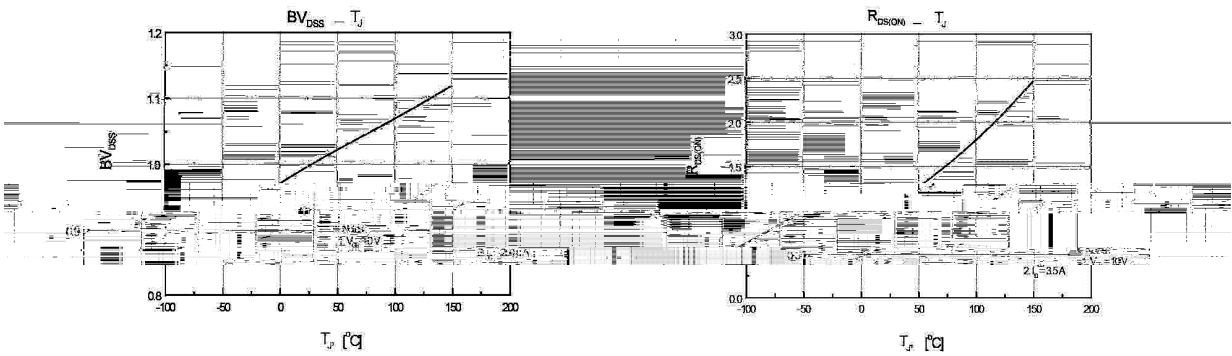
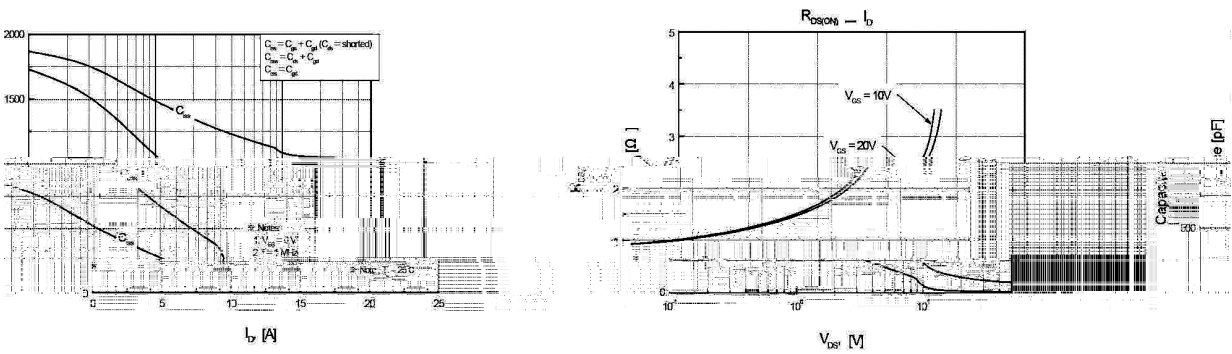
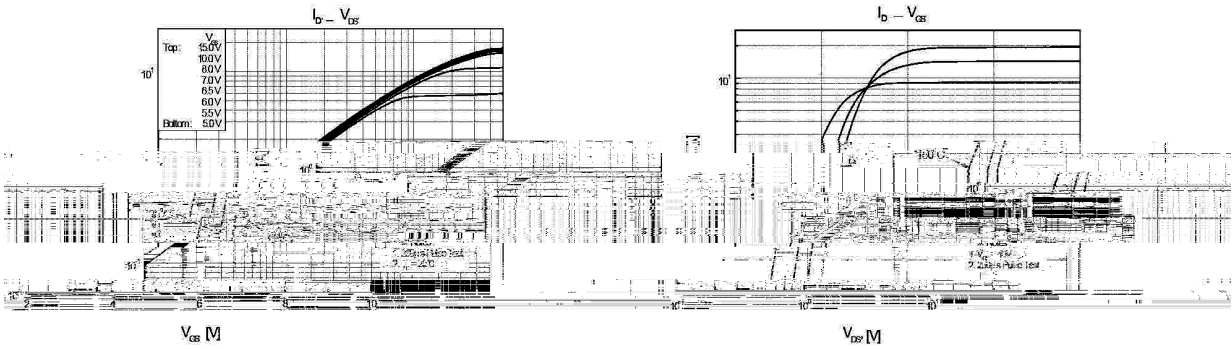
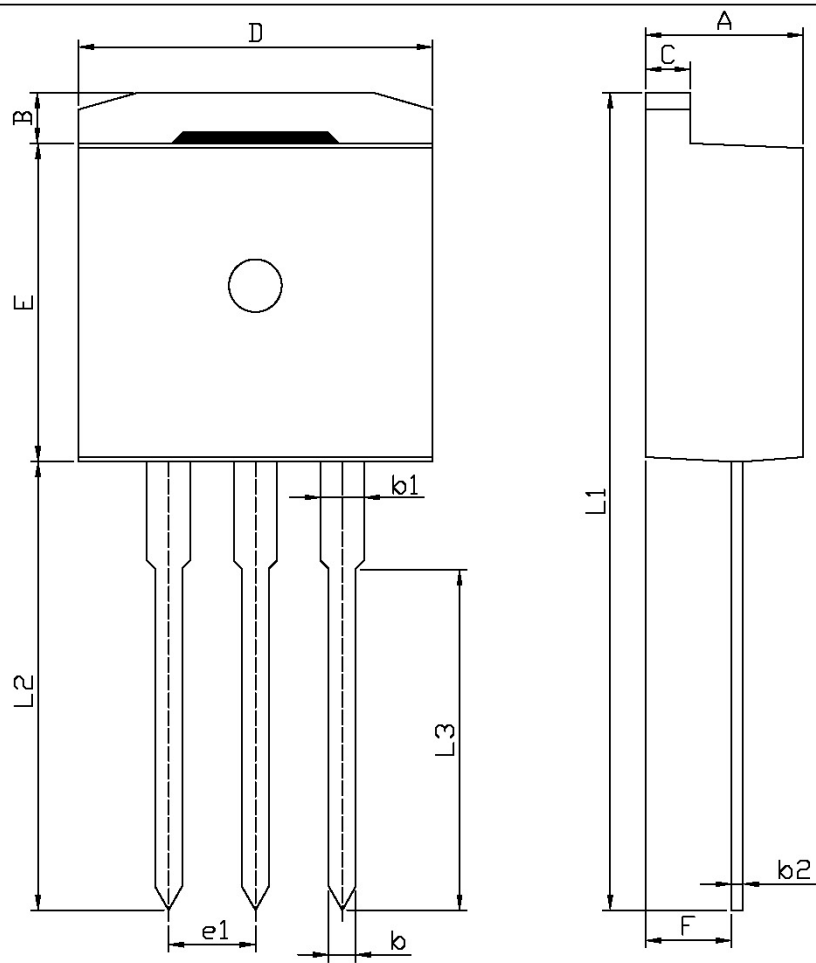

单位: mm

Symbol	Dimensions In. Millimeters		Symbol	Dimensions In. Millimeters	
	Min	Max		Min	Max
A	4.30	4.70	E	9.00	9.40
B	1.00	1.40	e1	2.34	2.74
b	0.70	0.90	F	2.20	2.60
b1	1.27		L1	22.60	23.60
b2	0.40	0.60	L2	12.60	13.60
C	1.20	1.40	L3	9.60	10.60
D	9.80	10.20			

T0-262

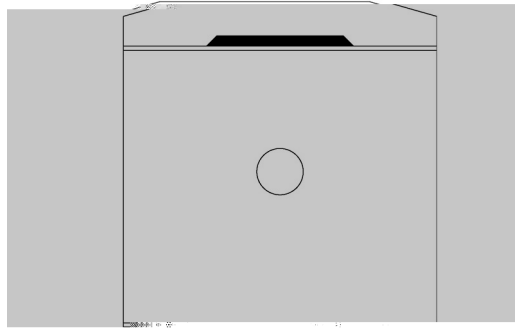

7N65
