



## / Descriptions

P 沟道 塑封封装场效应管。  
P

## / Features

$R_{DS(on)}$ 小，大电流输出能力。无卤产品。

## / Applications

交流负载开关，蓄电池充电/放电保护。

## / Equivalent Circuit

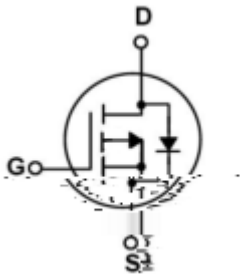

## / Pinning



: : : :

## / $h_{FE}$ Classifications & Marking

见印章说明。

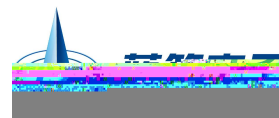

**/ Absolute Maximum Ratings(Ta=25 )**

		°C		
		°C		
		°C		
		.	~	°C
	≦	θ		°C
		θ		

**/ Electrical Characteristics(Ta=25 )**

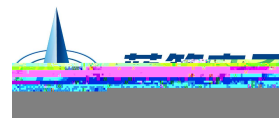

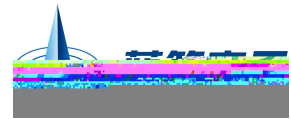

/ Electrical Characteristics(Ta=25 )



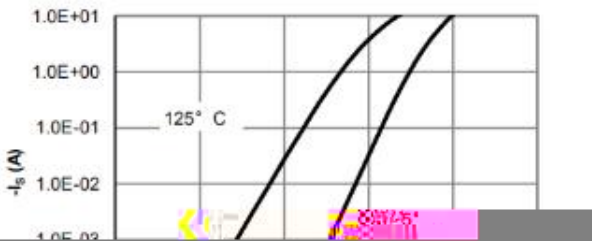
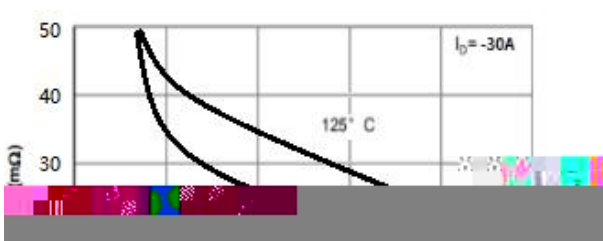
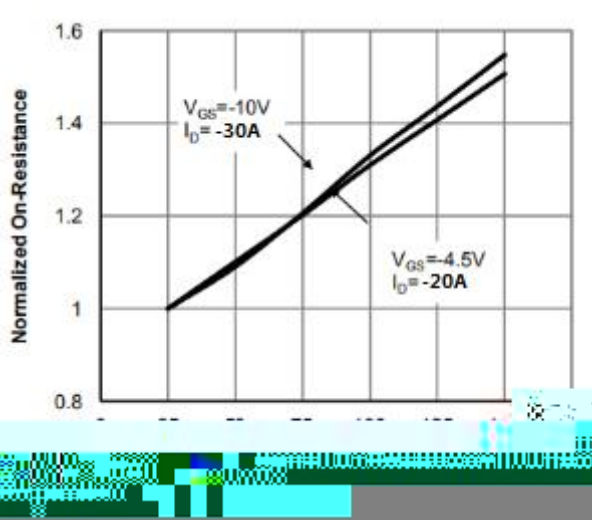
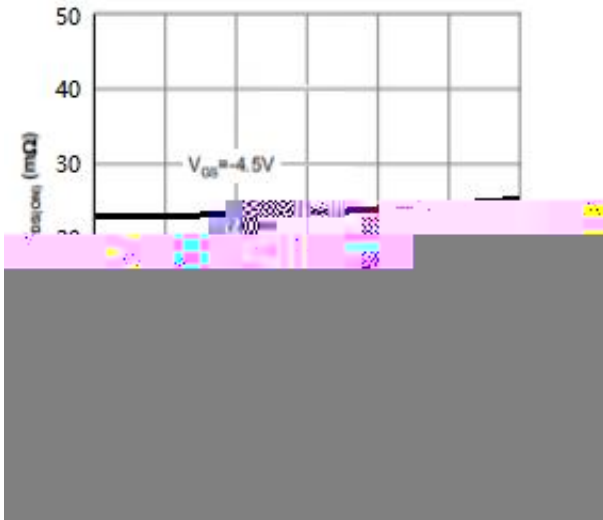
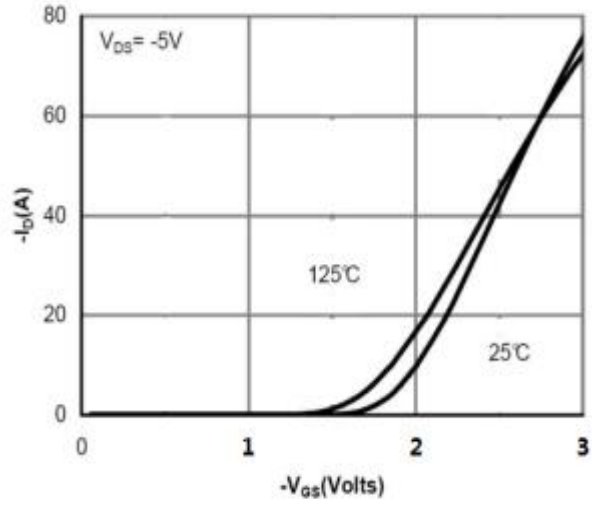
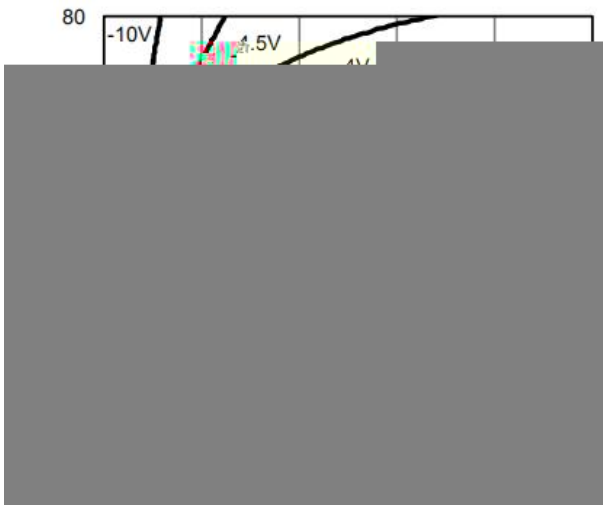

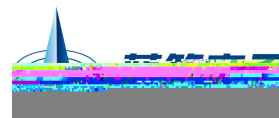
/ Electrical Characteristic Curve



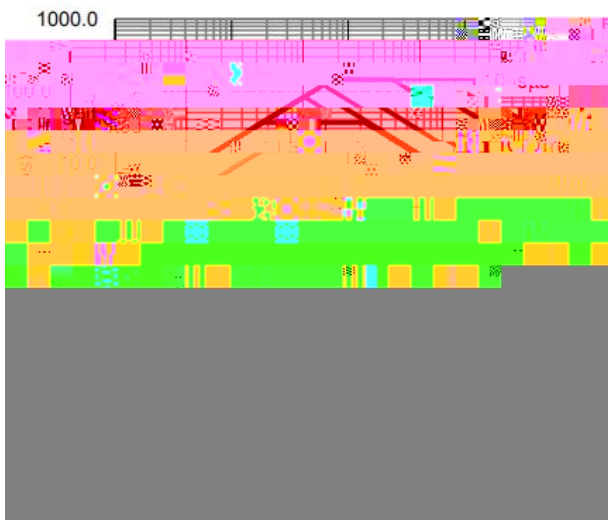
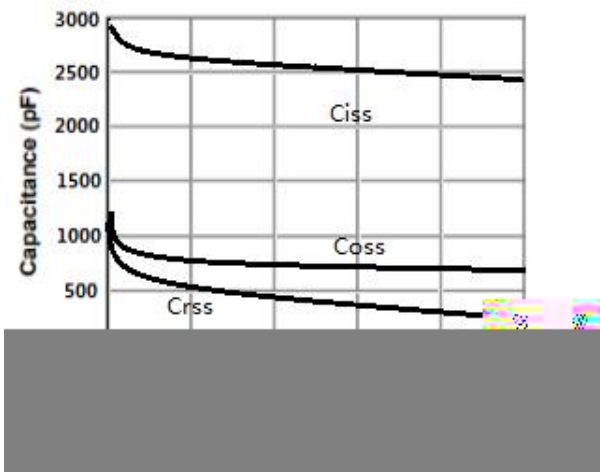

/ Electrical Characteristic Curve



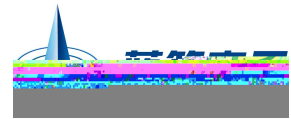

/ Package Dimensions

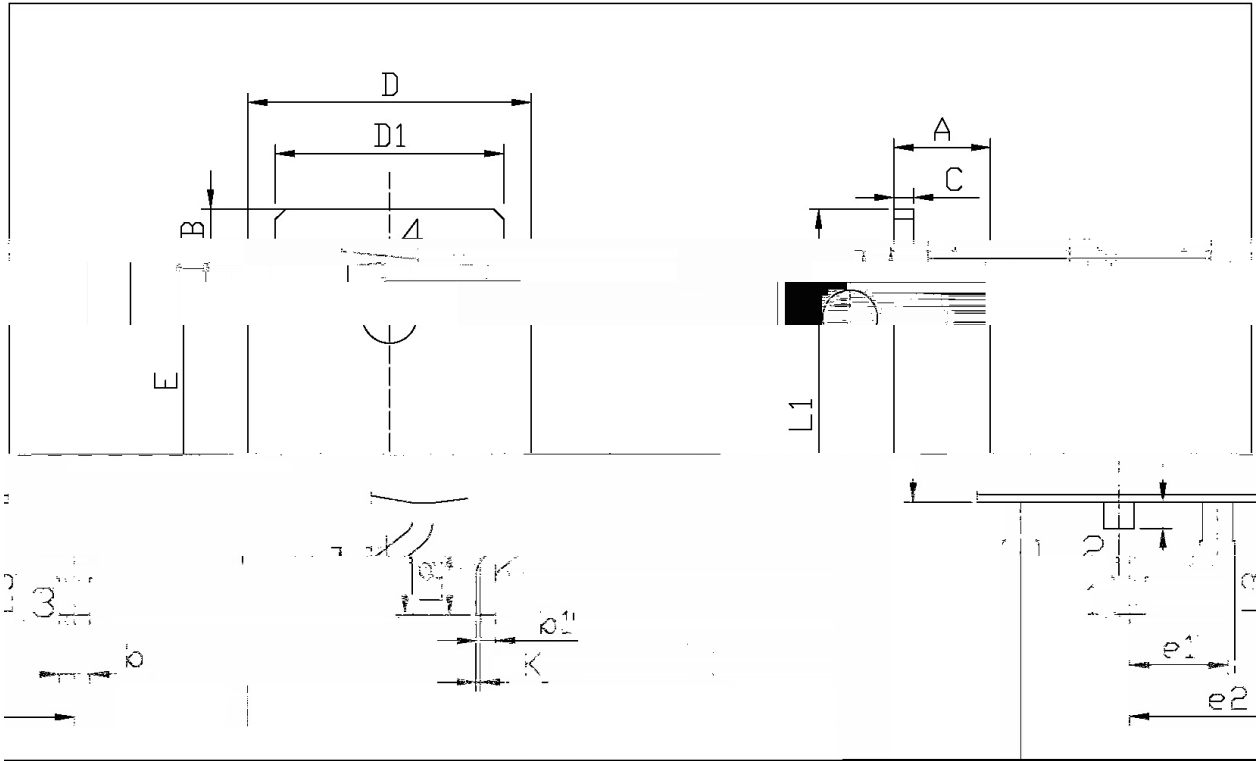

单位: mm

Symbol	Dimension		Symbol	Dimension	
	Min.	Max.		Min.	Max.
E	6.95	6.25	A	2.29	2.49
D1	4.43	4.73	B	0.50	0.70
L1	9.45	9.95	b10	0.45	0.55
D	1.25	1.75	C	0.45	0.55
phi	0.60	0.90	D	6.45	6.75
D1	5.10	5.50	K	0.00	0.10

TC\_25

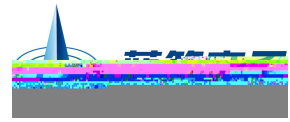

**/ Marking Instructions**

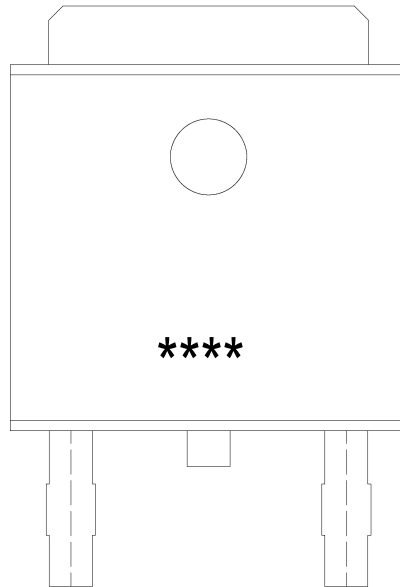

**\*\*\*\***

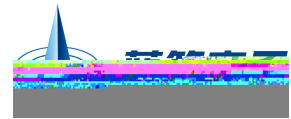

( ) / Temperature Profile for IR Reflow Soldering(Pb-Free)

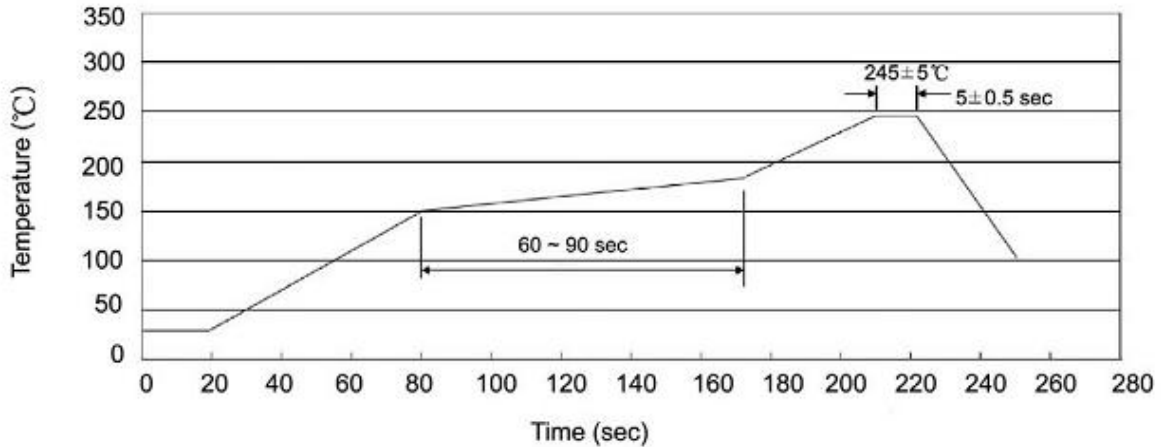

说明：

- 、预热温度 ~ °C，时间 ~
- 、峰值温度 ± °C，时间持续为 ± ± ±
- 、焊接制程冷却速度为 ~

/ Resistance to Soldering Heat Test Conditions

温度： ± 时间： ± °C

/ Packaging SPEC.

卷盘包装

封装形式	包装数量					包装尺寸		
	Units/Reel 只/卷盘	Reels/Inner Box 卷盘/盒	Units/Inner Box 只/盒	Inner Boxes/Outer Box 盒/箱	Units/Outer Box 只/箱	Reel	Inner Box 盒	Outer Box 箱
TO-252	2,500	2	5,000	5	25,000	13" × 16	360×360×50	385×257×392

套管包装

封装形式	包装数量					包装尺寸		
	Units/Tube 只/套管	Tubes/Inner Box 套管/盒	Units/Inner Box 只/盒	Inner Boxes/Outer Box 盒/箱	Units/Outer Box 只/箱	Tube 套管	Inner Box 盒	Outer Box 箱
TO-251/252	75	48	3,600	5	18,000	526×20.5×5.25	555×164×50	575×290×180

/ Notices