

Rev.A Sep.-2022

N TO-263

N-CHANNEL MOSFET in a TO-263 Plastic Package.

Parameter	Symbol	Rating	Unit
Drain-Source Voltage	V_{DS}	60	V
Drain Current	$I_D(T_c=25^\circ\text{C})$	50	A
Drain Current - Pulsed	I_{DM}	200	A
Gate-Source Voltage	V_{GS}	± 20	V
Avalanche Current	I_{AS}	20	A
Single Pulsed Avalanche Energy	E_{AS}	170	mJ
Power Dissipation	$P_D(T_c=25^\circ\text{C})$	75	W
Storage Temperature Range	T_{stg}	-55 150	

Parameter	Symbol	Test Conditions	Min	Typ	Max	Unit
Turn-On Delay Time	$t_{d(on)}$	$V_{GS}=10V$ $V_{DS}=30V$ $R_L=1.5$ $R_{GEN}=3$		8		ns
Turn-On Rise Time	t_r			5		
Turn-Off Delay Time	$t_{d(off)}$			30		
Turn-Off Fall Time	t_f			5.5		

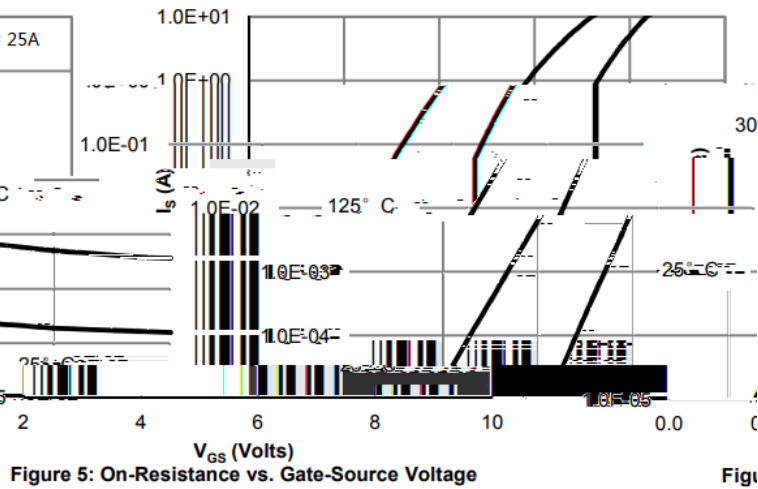
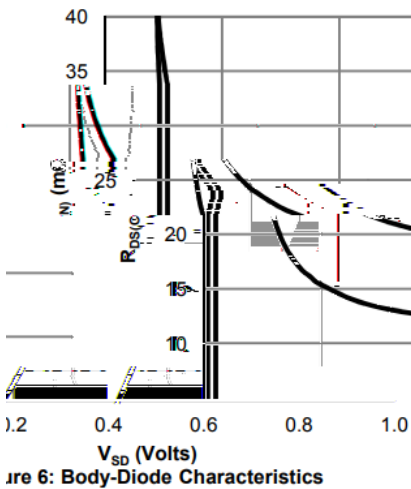
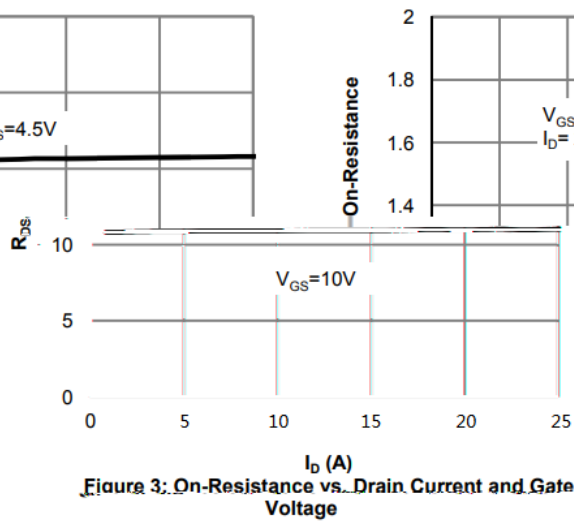
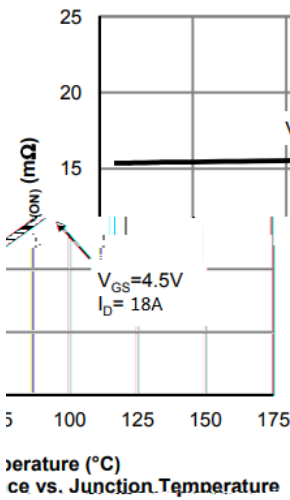
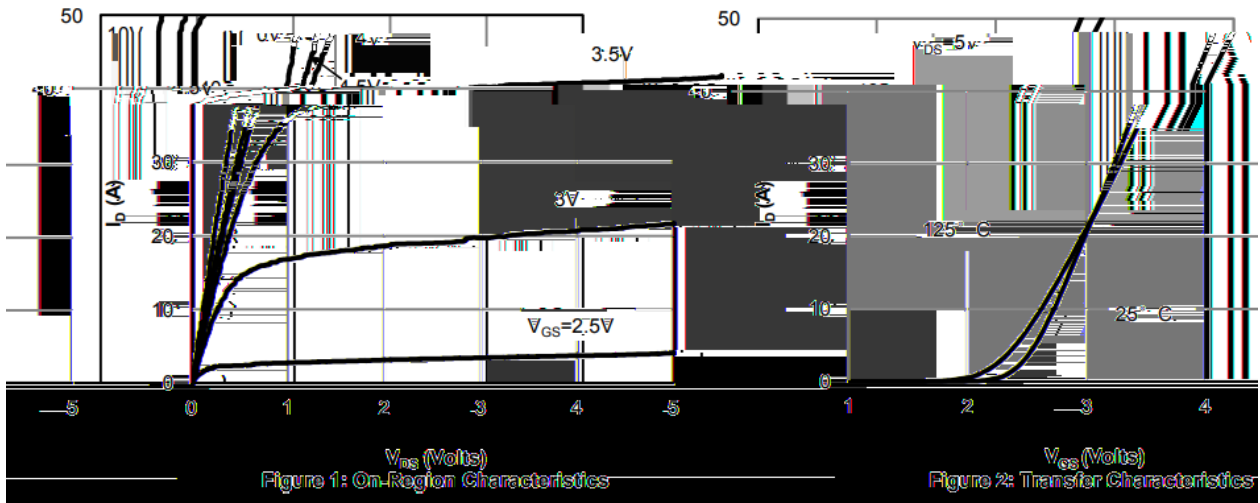

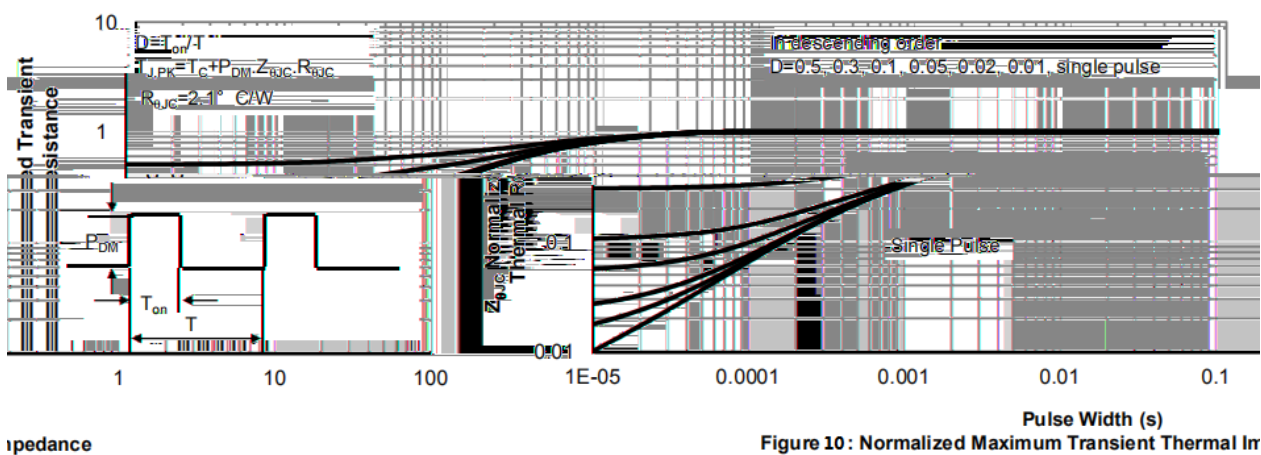
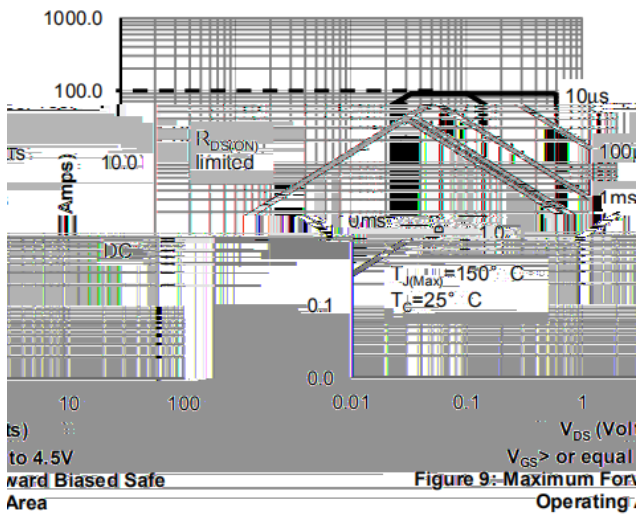
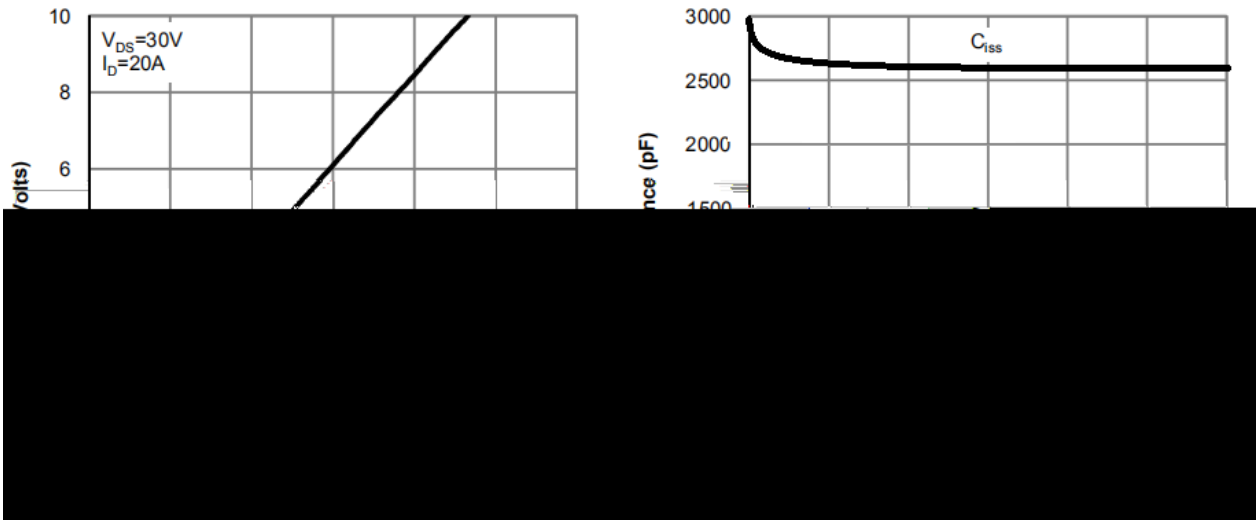

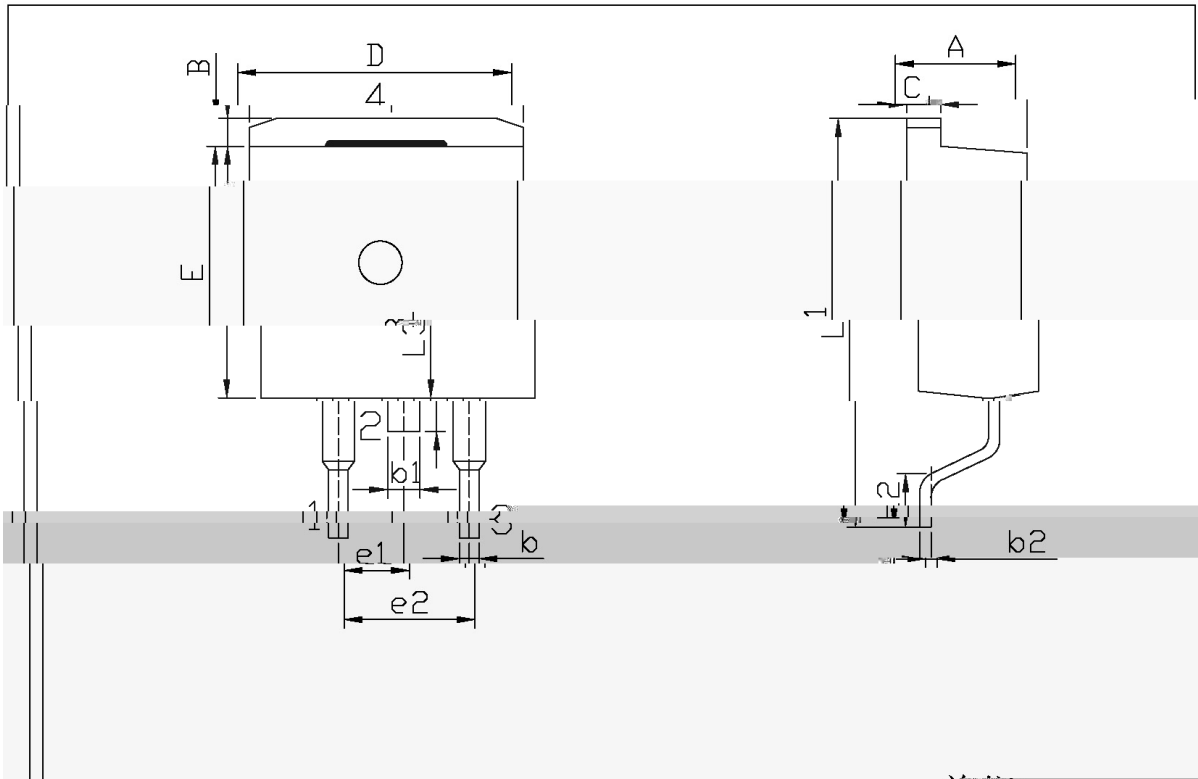

单位: mm

Symbol	Dimensions In Millimeters		Symbol	Dimensions In Millimeter	
	Min	Max		Min	Max
A	4.30	4.70	E	9.00	9.40
B	1.00	1.40	e1	2.20	2.70

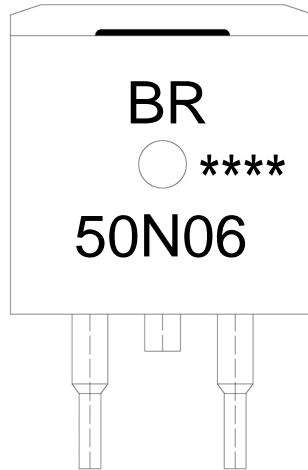

Note:

BR: Company Code

50N06: Product Type

****: Lot No. Code, code change with Lot No

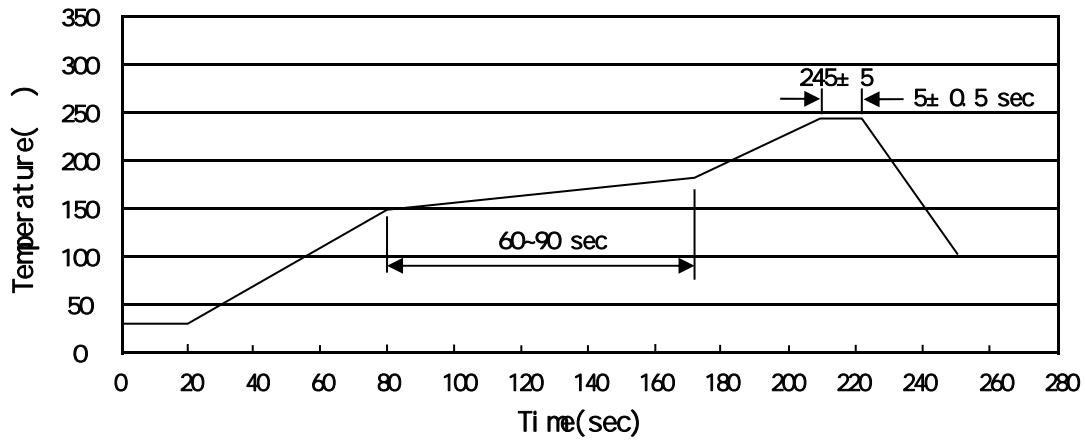

Note:

- | | | | | | |
|---|-----|-----|----|----------|---|
| 1 | 150 | 180 | 60 | 90sec; | 1.Preheating:150~180 , Time:60~90sec. |
| 2 | 245 | 5 | 5 | 0.5sec; | 2.Peak Temp.:245 5 , Duration:5 0.5sec. |
| 3 | | | 2 | 10 /sec. | 3. Cooling Speed: 2~10 /sec. |

260 ± 5 10 ± 1 sec. Temp.:260±5 Time:10±1 sec

/ REEL

Package Type	Units					Dimension (unit mm ³)		
	Units/Reel	Reels/Inner Box	Units/Inner Box	Inner Boxes/Outer Box	Units/Outer Box	Reel	Inner Box	Outer Box
TO-263	800	1	800	6	4,800	13 ×24	360×360×50	380×335×366

/ TUBE

Package Type	Units					Dimension (unit mm ³)		
	Units/Tube	Tubes/Inner Box	Units/Inner Box	Inner Boxes/Outer Box	Units/Outer Box	Tube	Inner Box	Outer Box
TO-263	50	20	1,000	5	5,000	532×33×7.0	555×164×50	575×290×180