

/ Descriptions

/ Features

/ Applications

DC/DC

/ Equivalent Circuit

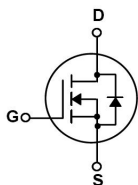

/ Pinning



/ h_{FE} Classifications & Marking

/ Electrical Characteristic Curve

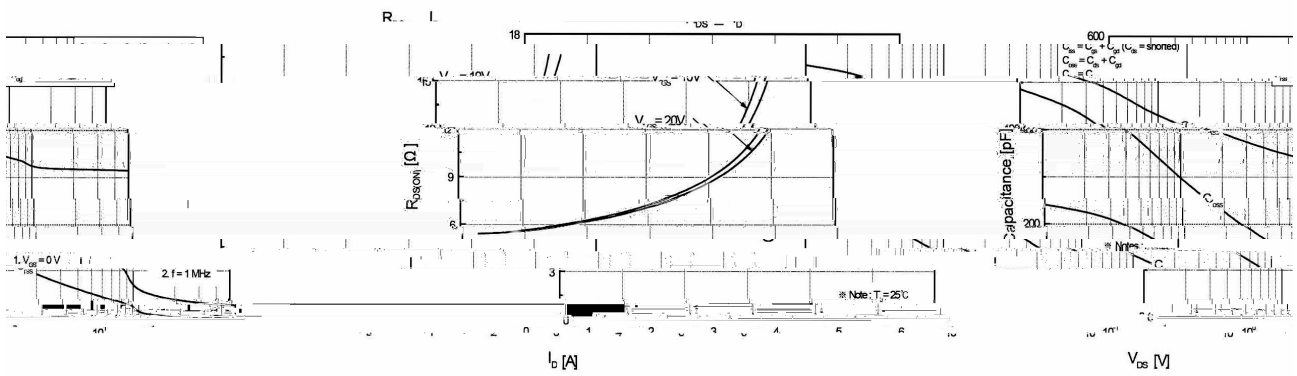
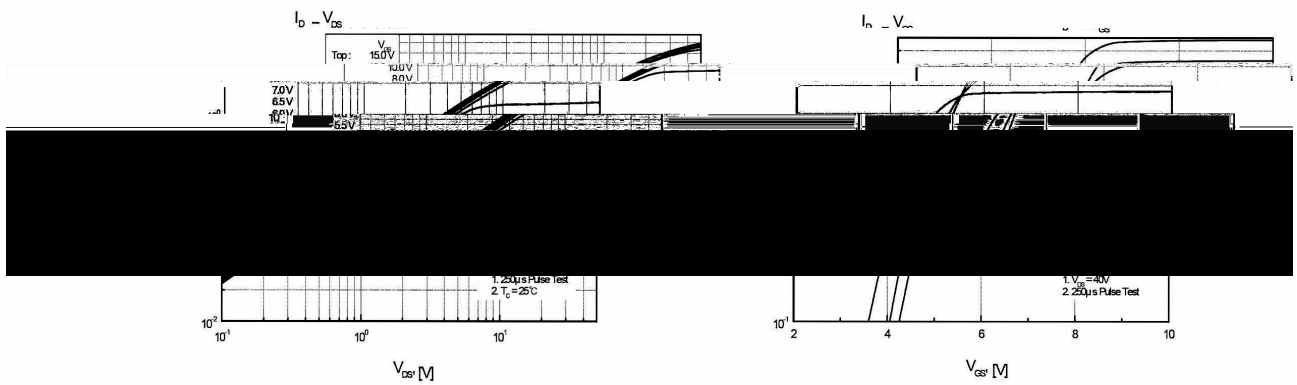
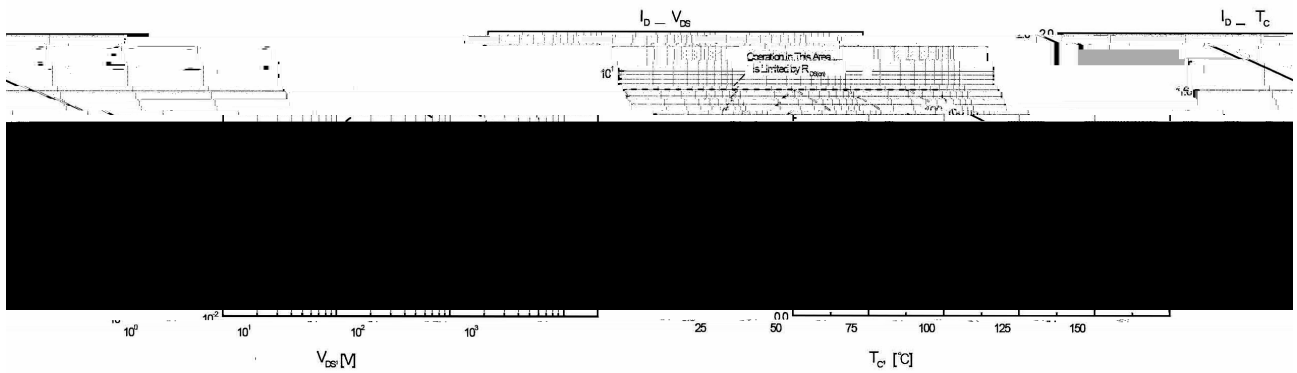
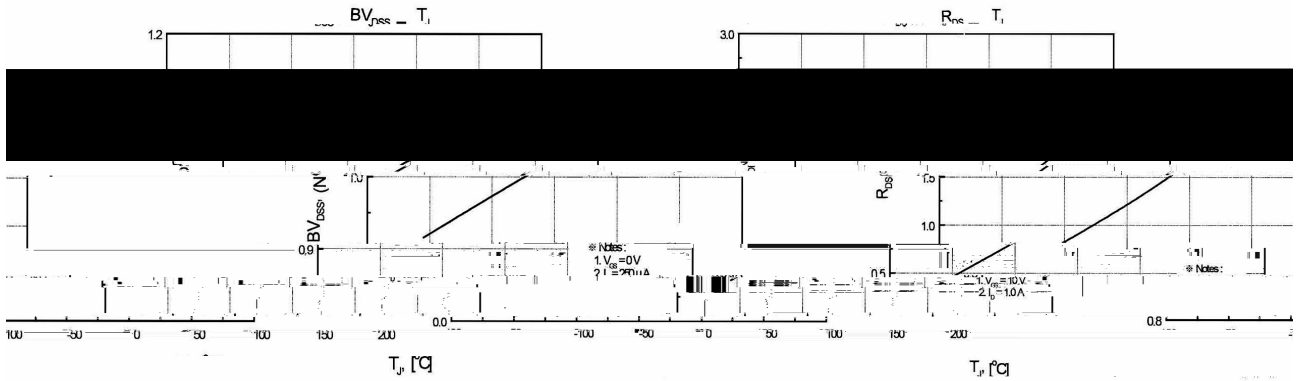

/ Package Dimensions

TO-220F

单位: mm

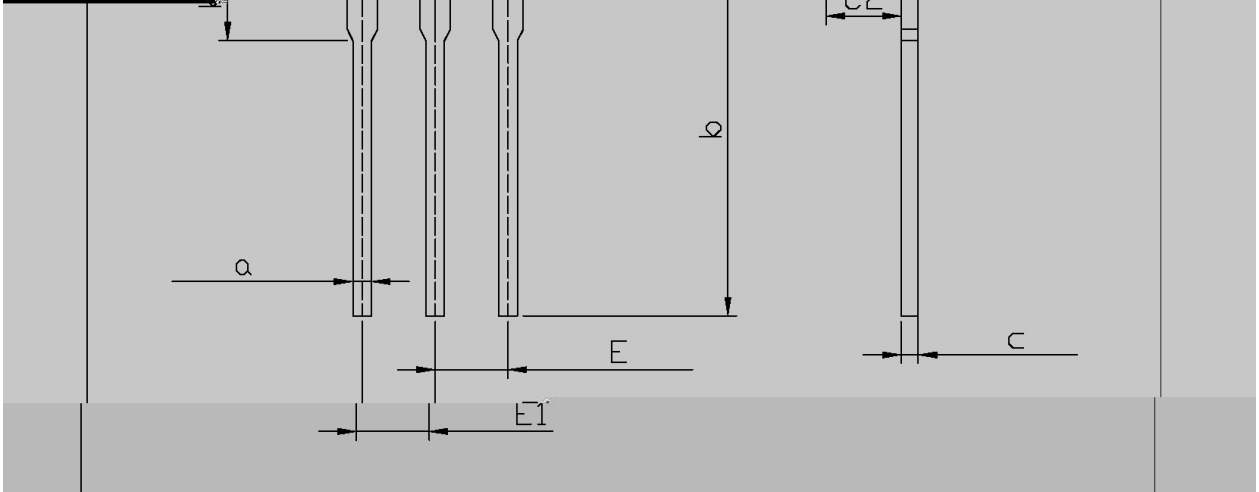

Dimensions In Millimeters			Dimensions In Millimeters		
Symbol	Min	Max	Symbol	Min	Max
C	4.3	4.7	b1	2.9	3.9
A	9.7	10.3	a	0.55	0.75
B	14.7	15.3	E	2.29	2.79
D1	3.8	4.0	E1	2.29	2.79
D2	2.9	3.1	C1	1.5	2.0

/ Marking Instructions

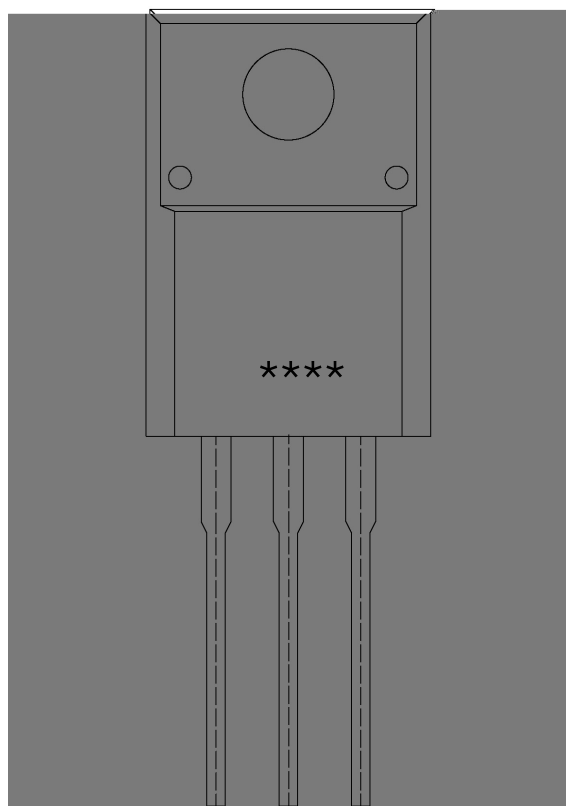

BRF2N65