

KF \$))' 8:

L GJ

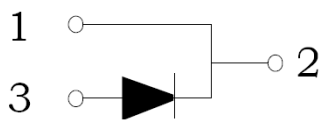





		μ				
		μ				
		μ				

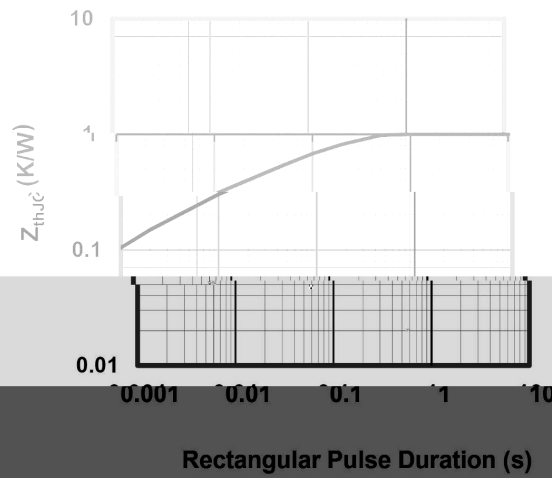
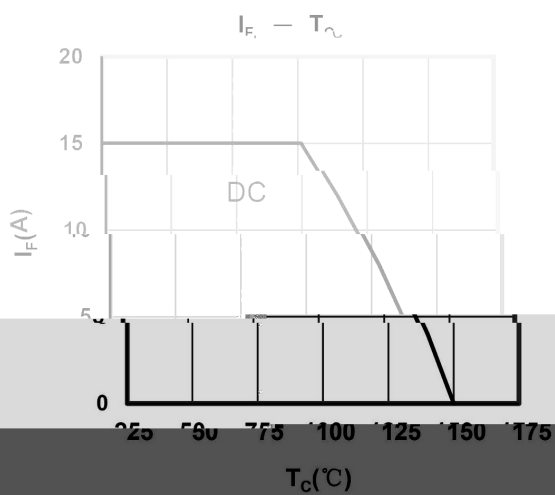
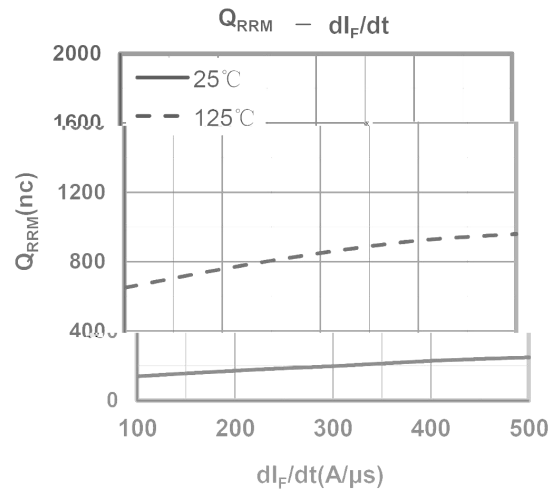
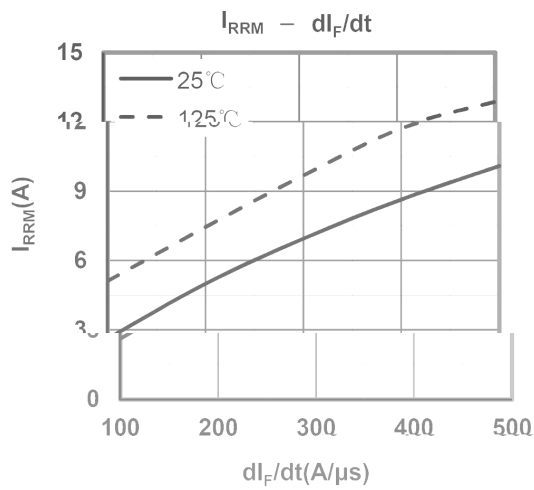
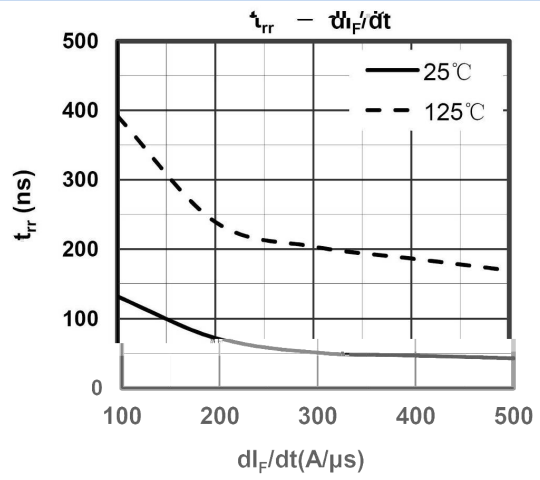
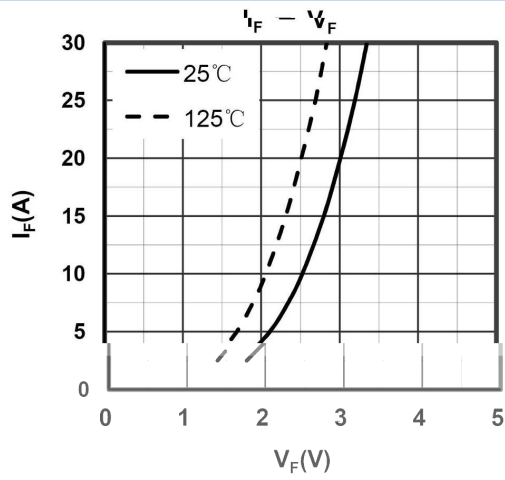

TO-220AC

Unit:mm

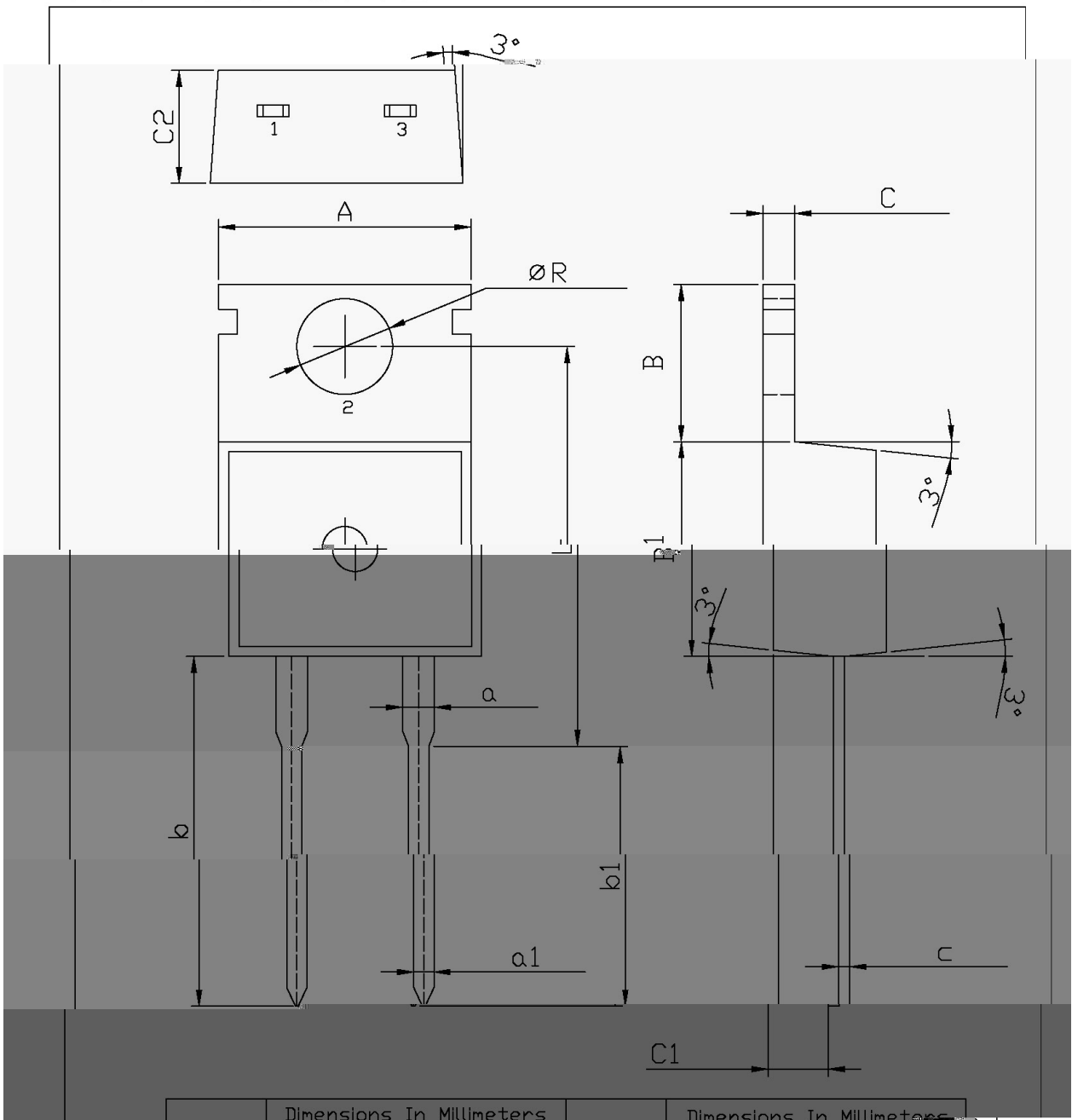

Dimensions In Millimeters			Dimensions In Millimeters		
Symbol	Min	Max	Symbol	Min	Max
A	9.8	10.2	B	6.3	6.7
R	3.56	3.64	B1	9.0	9.4

B1	9.0	9.4	C	6.7	6.8
a	1.22	1.32	C2	4.3	4.7
a1	0.7	0.9			

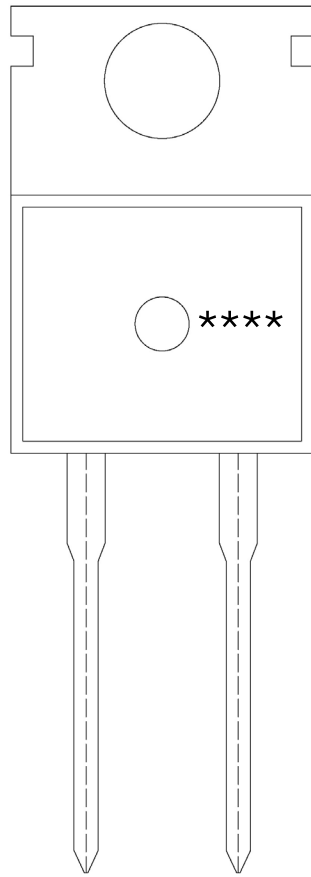

91
DLI (, ())
!!!!

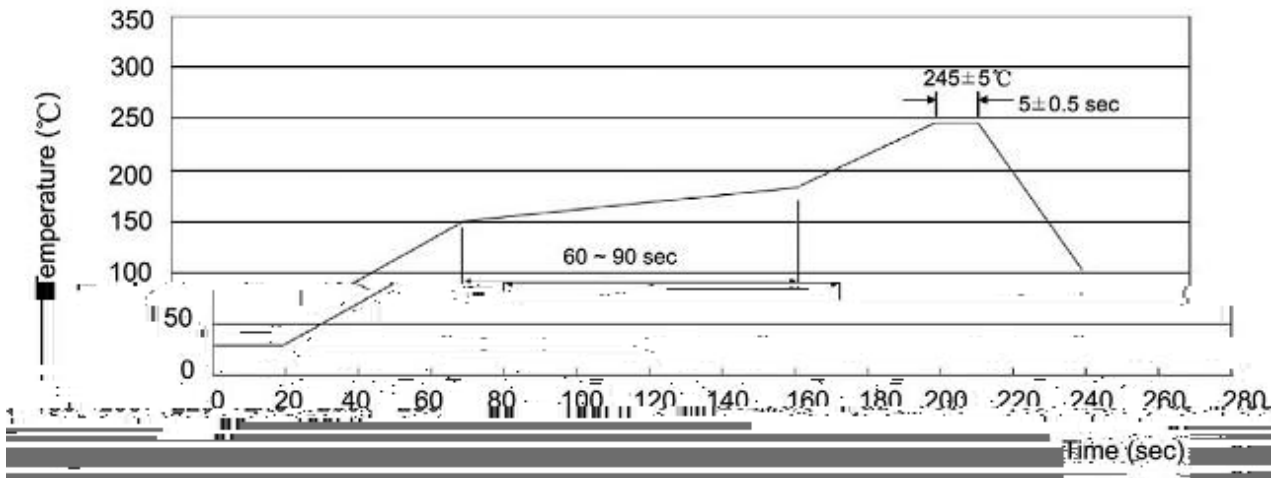

...

...

封装形式	包装数量					包装尺寸 :		
	Units/Bag 只/袋	Bags/Inner Box 袋/盒	Units/Inner Box 只/盒	Inner Boxes/Outer Box 盒/箱	Units/Outer Box 只/箱	Bag 袋	Inner Box 盒	Outer Box 箱
TO-220/F/AC	200	10	2,000	5	10,000	135×190	237×172×102	560×245×195

封装形式	包装数量					包装尺寸 :		
	Units/Tube 只/套管	Tubes/Inner Box 套管/盒	Units/Inner Box 只/盒	Inner Boxes/Outer Box 盒/箱	Units/Outer Box 只/箱	Tube 套管	Inner Box 盒	Outer Box 箱
TO-220/F/AC	50	20	1,000	5	5,000	532×31.4×5.5	555×164×50	575×290×180