

/ Descriptions

TO-3P

/ Features

TO-3P

600V

/ Applications

/ Equivalent Circuit

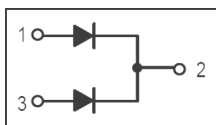

/ Pinning

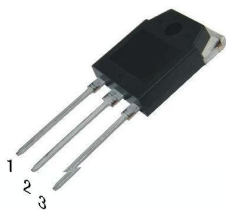

/ h_{FE} Classifications & Marking

/ Electrical Characteristic Curve

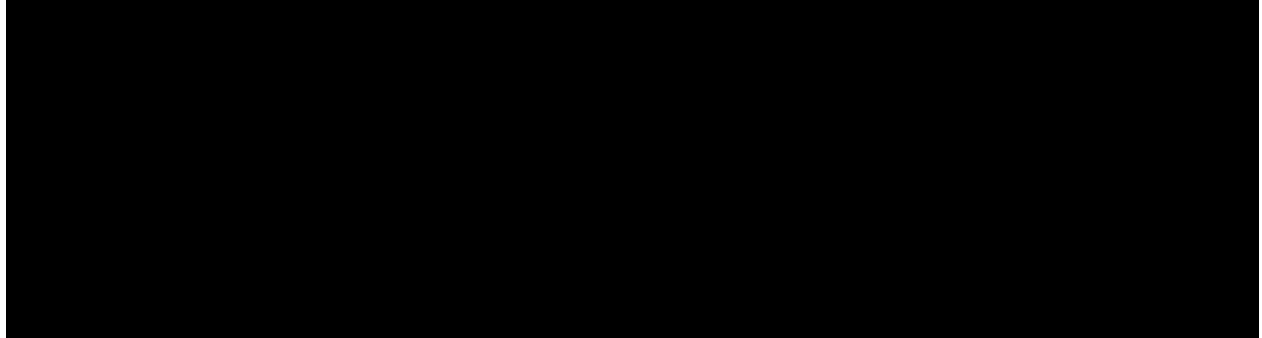
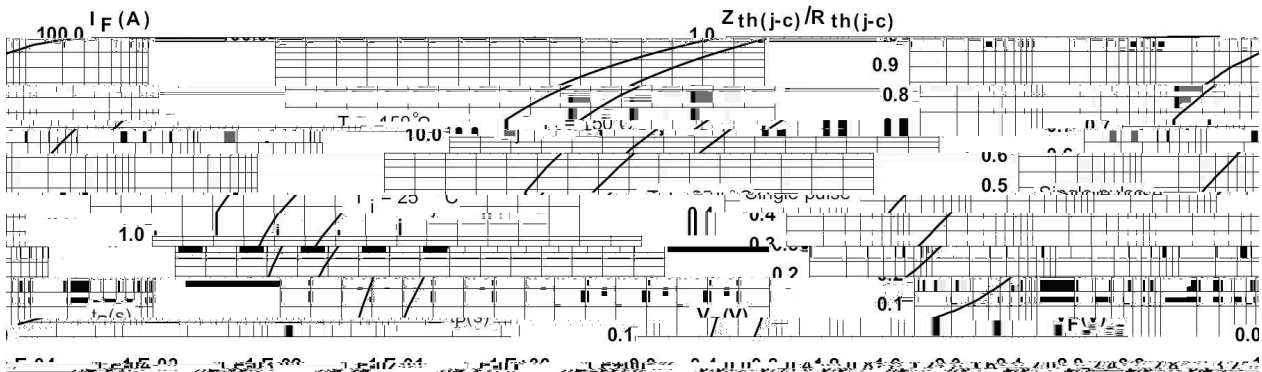
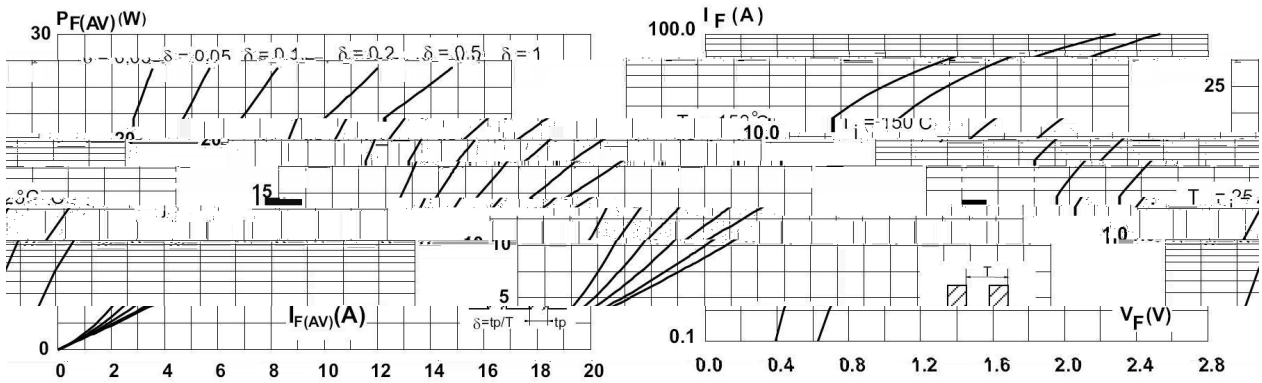

/ Electrical Characteristic Curve

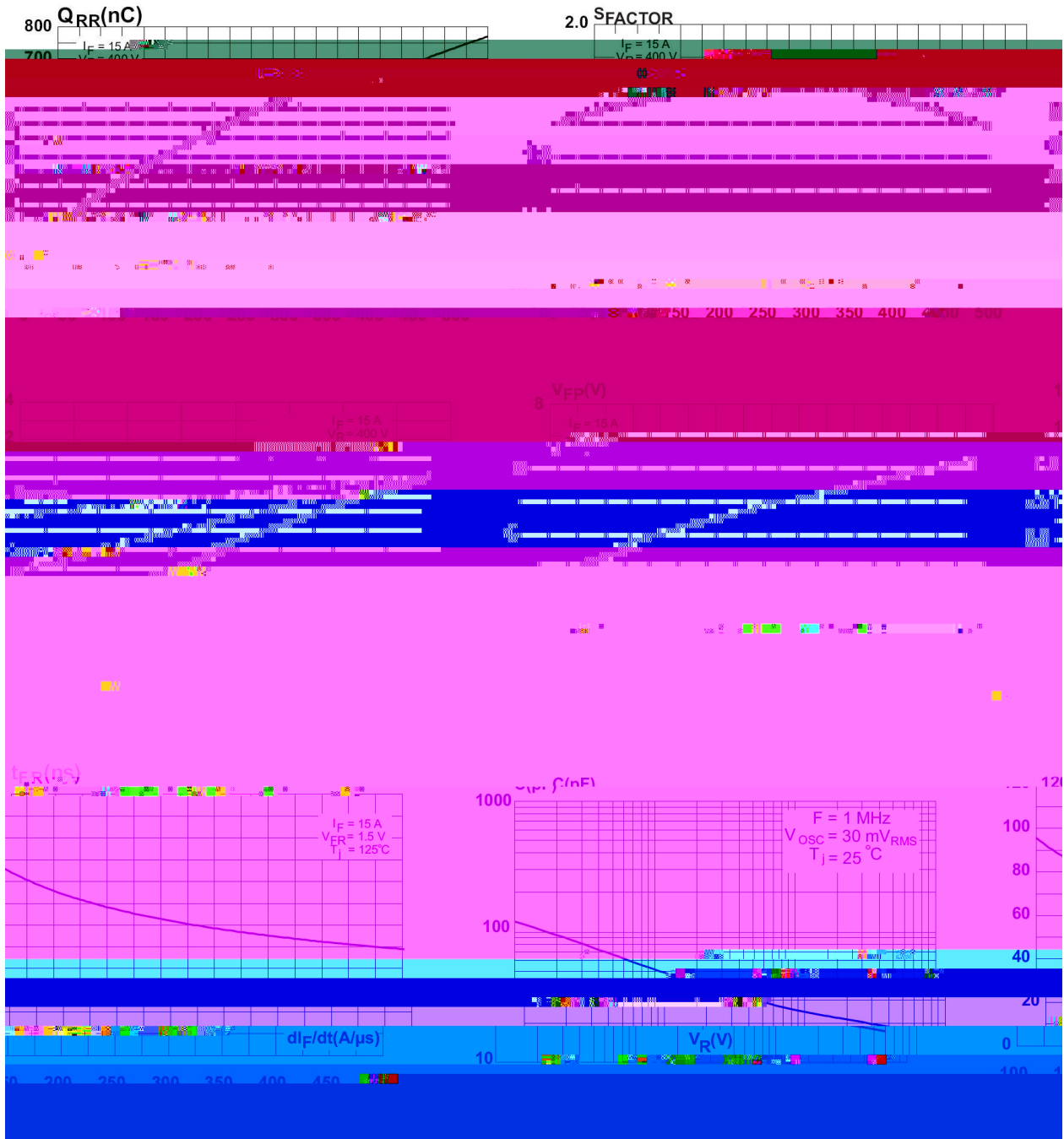

/ Package Dimensions

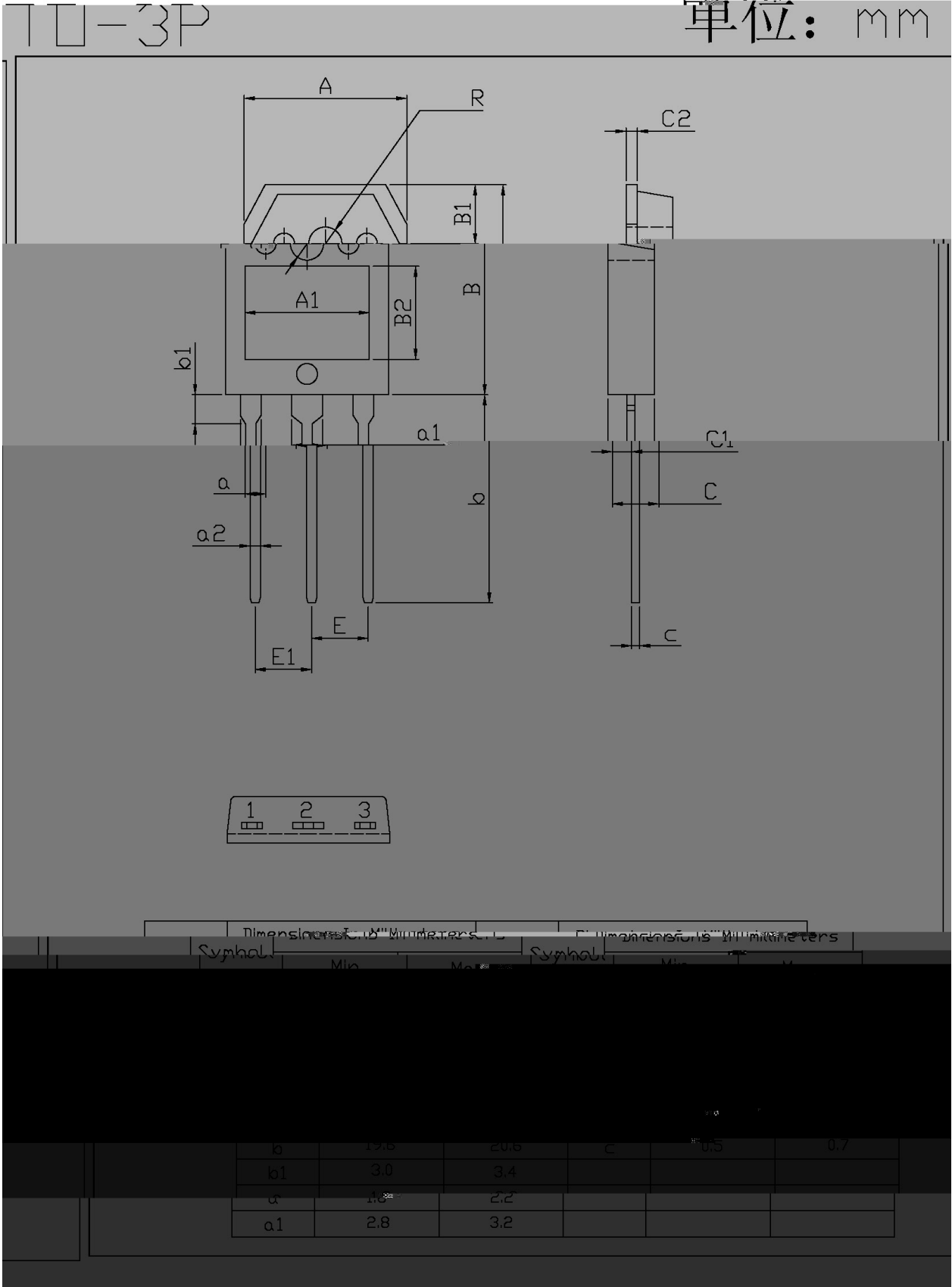

/ Marking Instructions

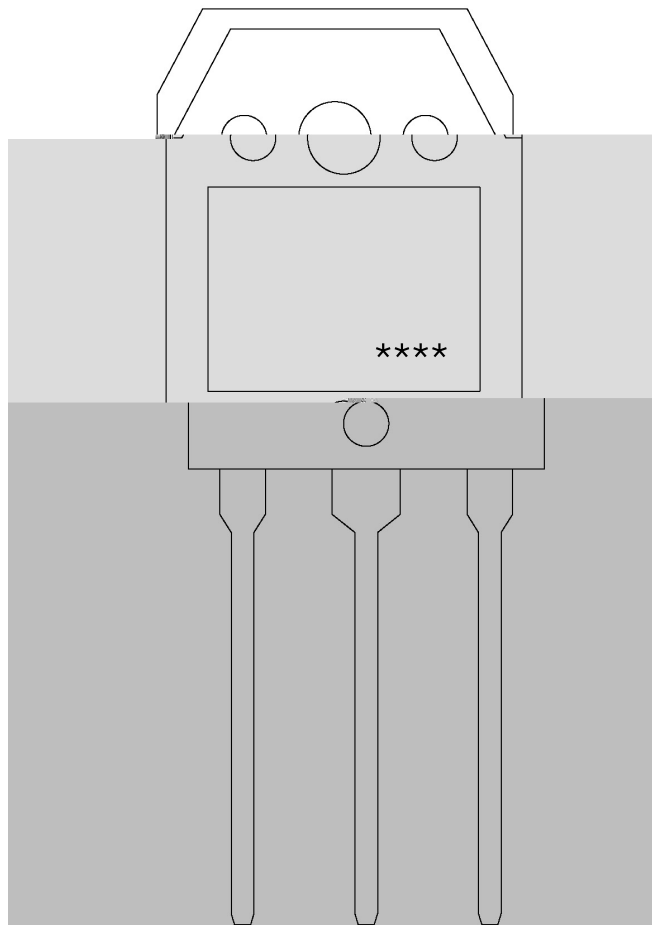

MUR3060PT

MUR3060PT

() / Temperature Profile for Dip Soldering(Pb-Free)

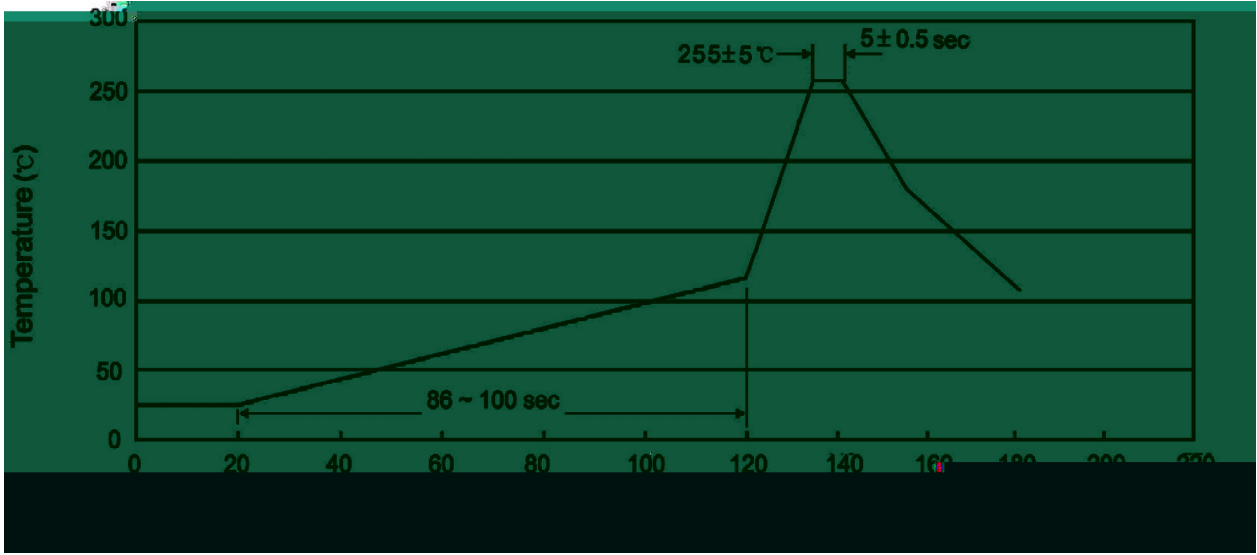

± ± ± ±

/ Resistance to Soldering Heat Test Conditions

± ±

/ Packaging SPEC.