

/ Descriptions

SOP-8

/ Features

/ Applications

/ Equivalent Circuit

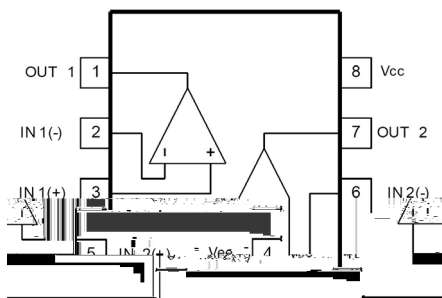

/ Pinning

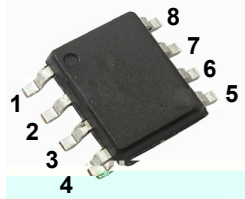

PIN

/

/ Marking

		±	
		±	
		±	

--	--	--	--	--	--	--	--

/ Functional Block Diagram

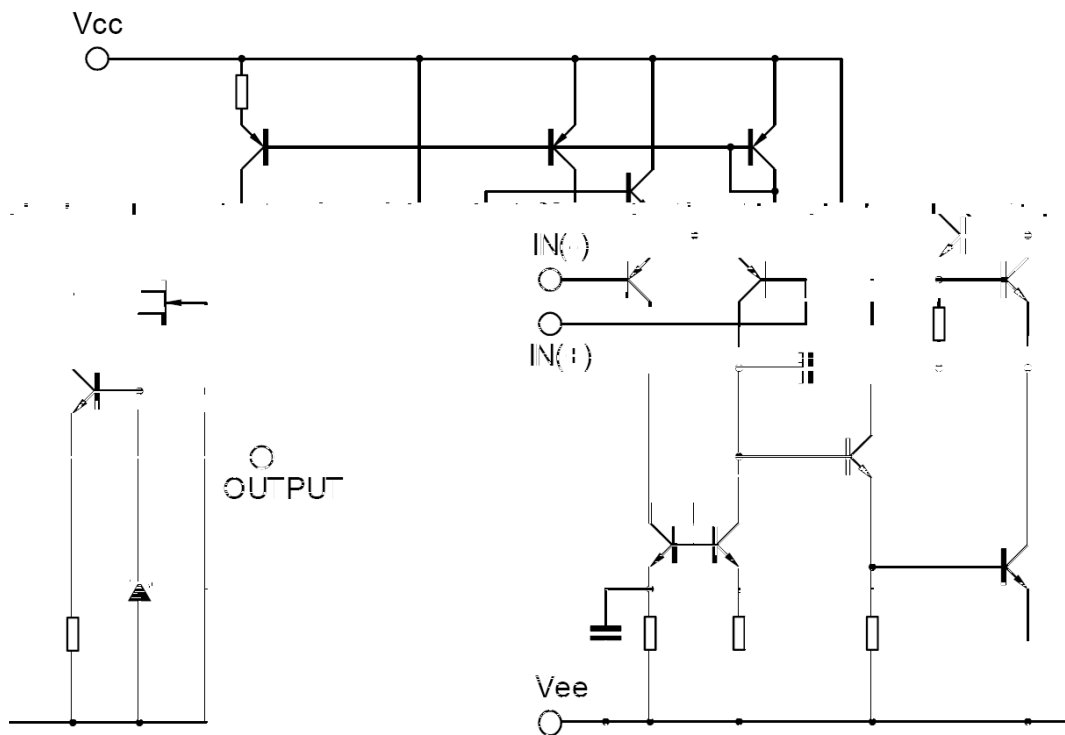

/ Electrical Characteristic Curve

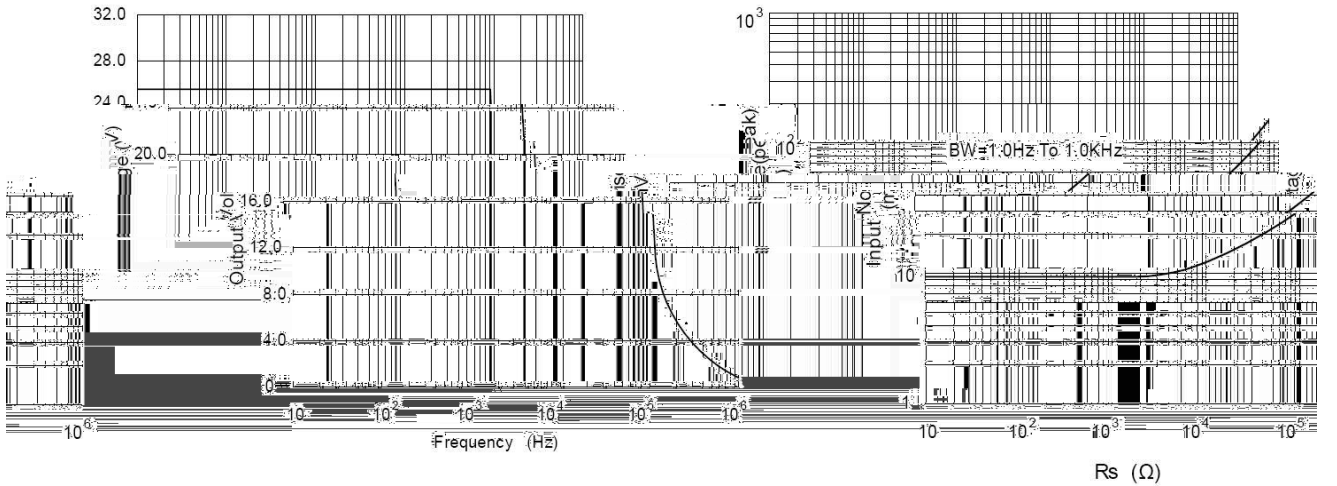
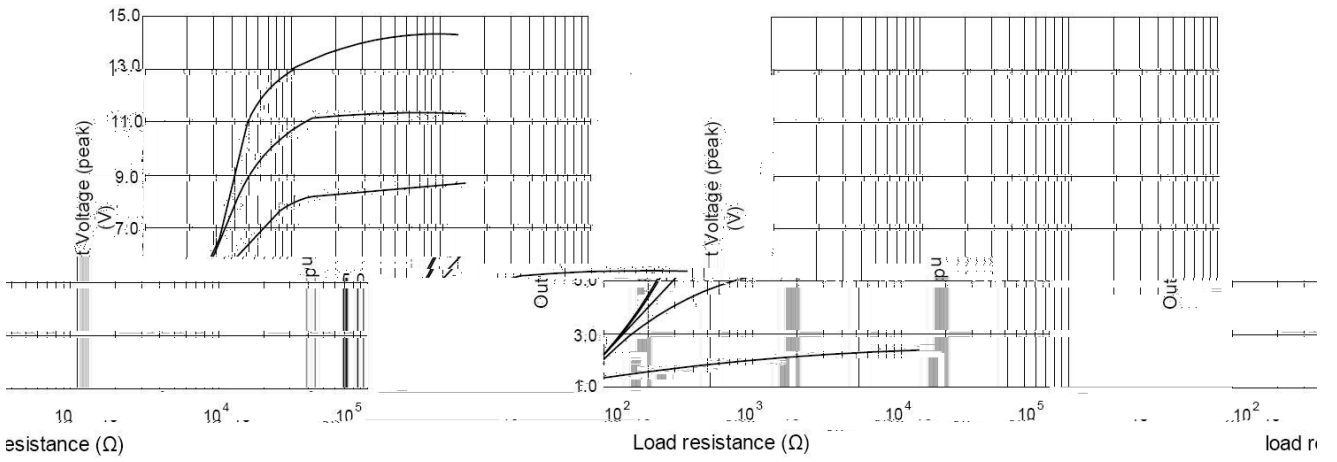

BROP4558SC

DATA SHEET r6i33.51 T115

/ Package Dimensions

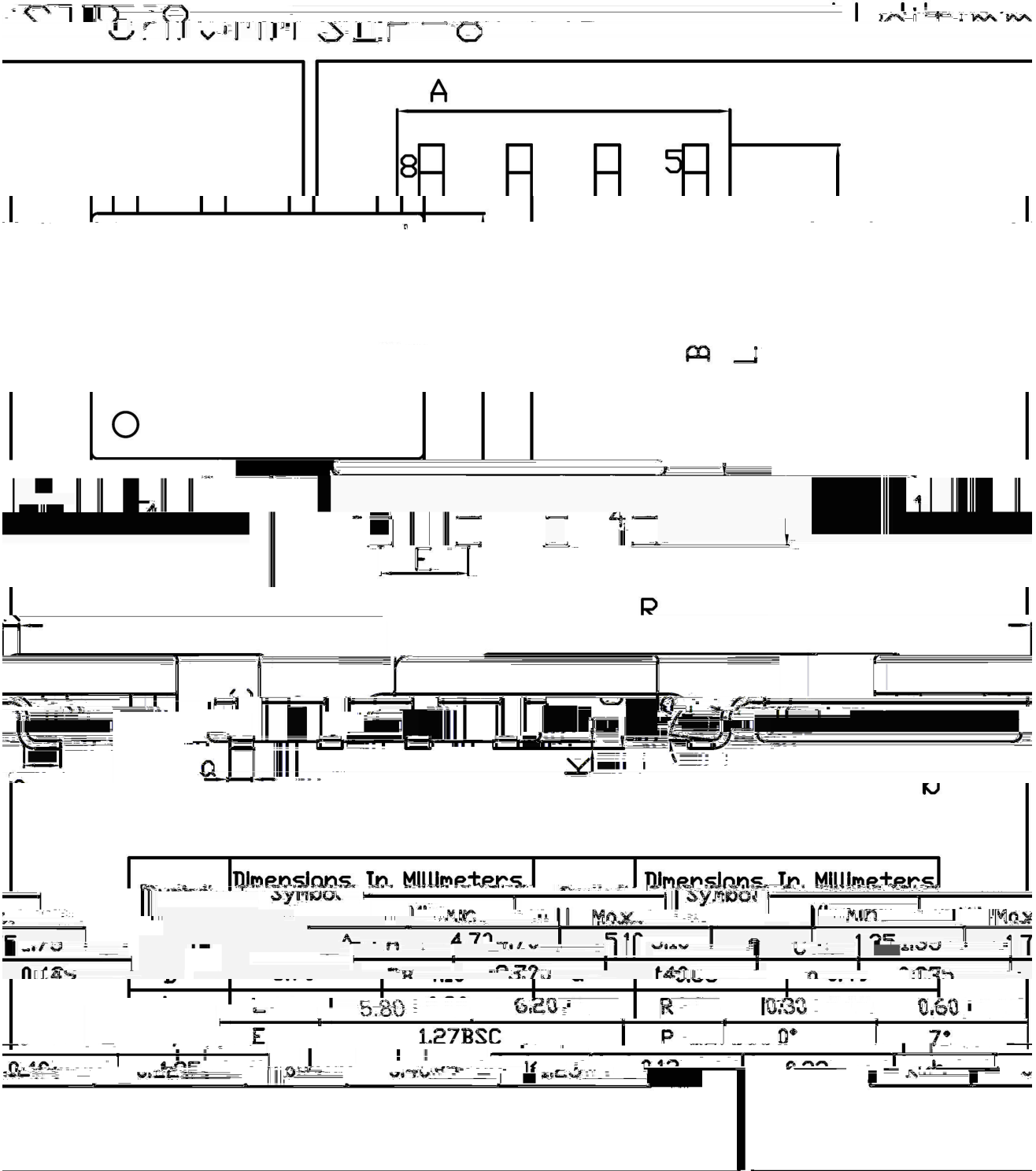

/ Marking Instructions

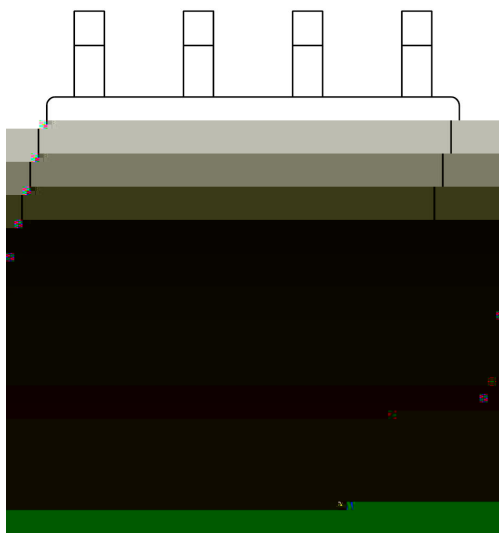

4558

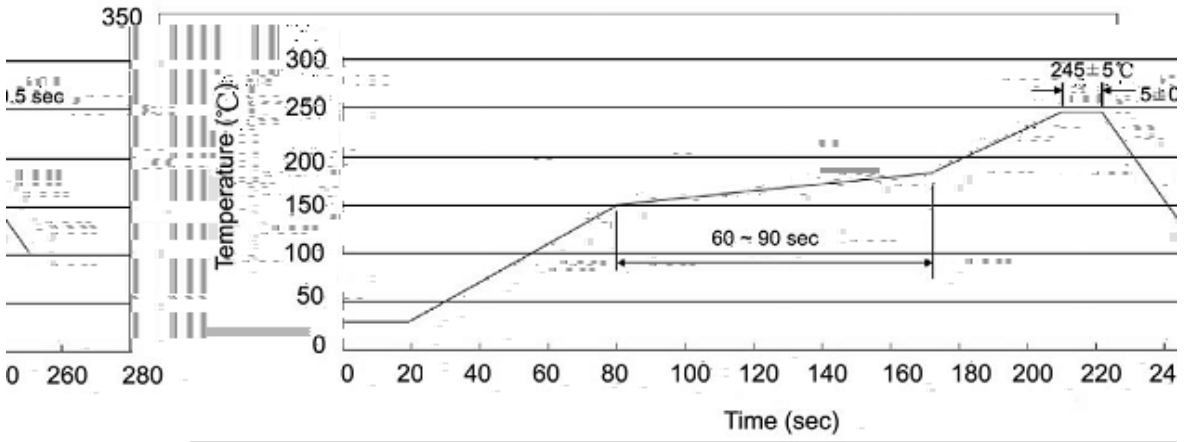

± ± ± ±

/ Resistance to Soldering Heat Test Conditions

± ± ± ±

/ Packaging SPEC.

封装形式	Units/Reel 只/卷盘	Reels/Inner Box 卷盘/盒	包装数量	包装尺寸 :
------	--------------------	-------------------------	------	--------