

## / Descriptions

TO-92      NPN

## / Features

VHF/UHF

## / Applications

## / Equivalent Circuit

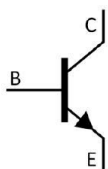

## / Pinning



## / hFE Classifications & Marking

**/ Absolute Maximum Ratings(Ta=25 )**

		°C	
			°C
			°C

**/ Electrical Characteristics(Ta=25 )**

		μ				
		μ				
						μ
						μ

/ Electrical Characteristic Curve

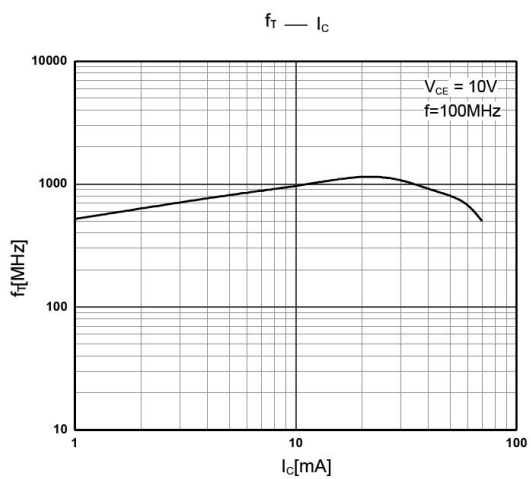
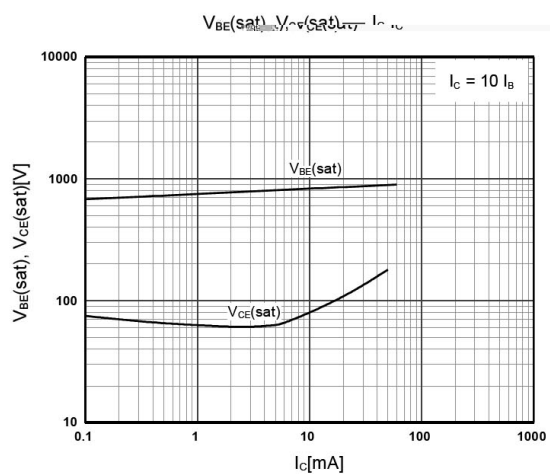
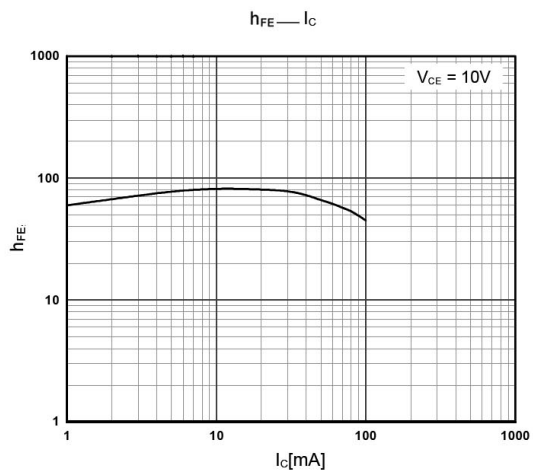

/ Package Dimensions

TO-92

Unit: mm

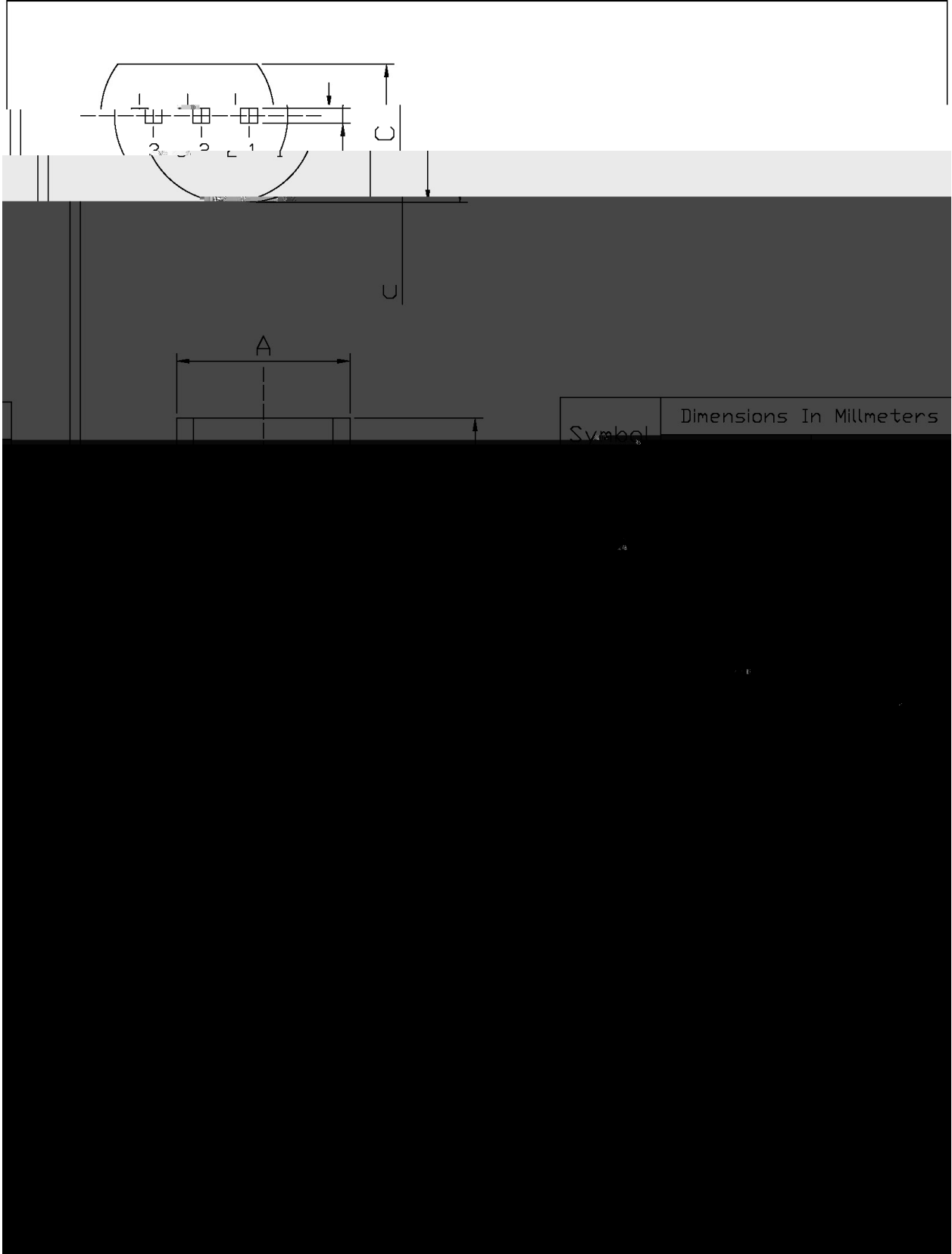

/ Marking Instructions

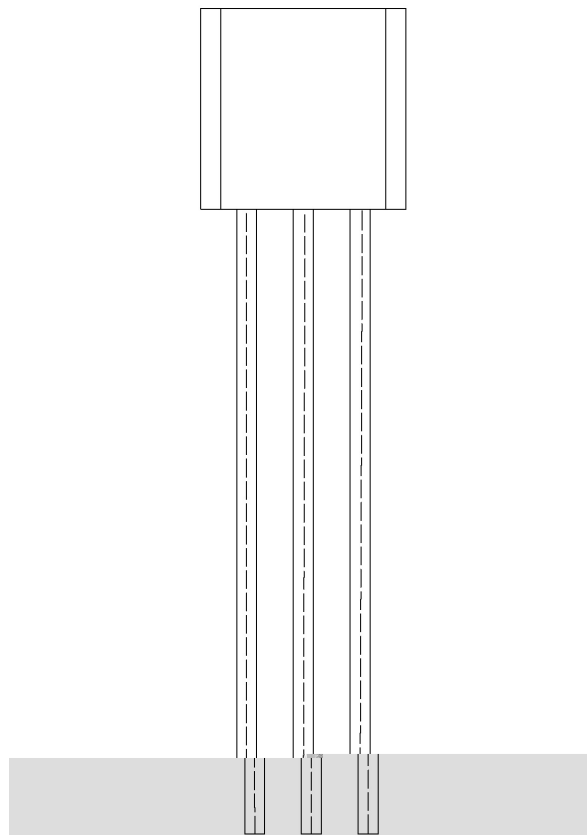

BR:  
KSP10  
\*\*\*\*

( ) / Temperature Profile for Dip Soldering(Pb-Free)

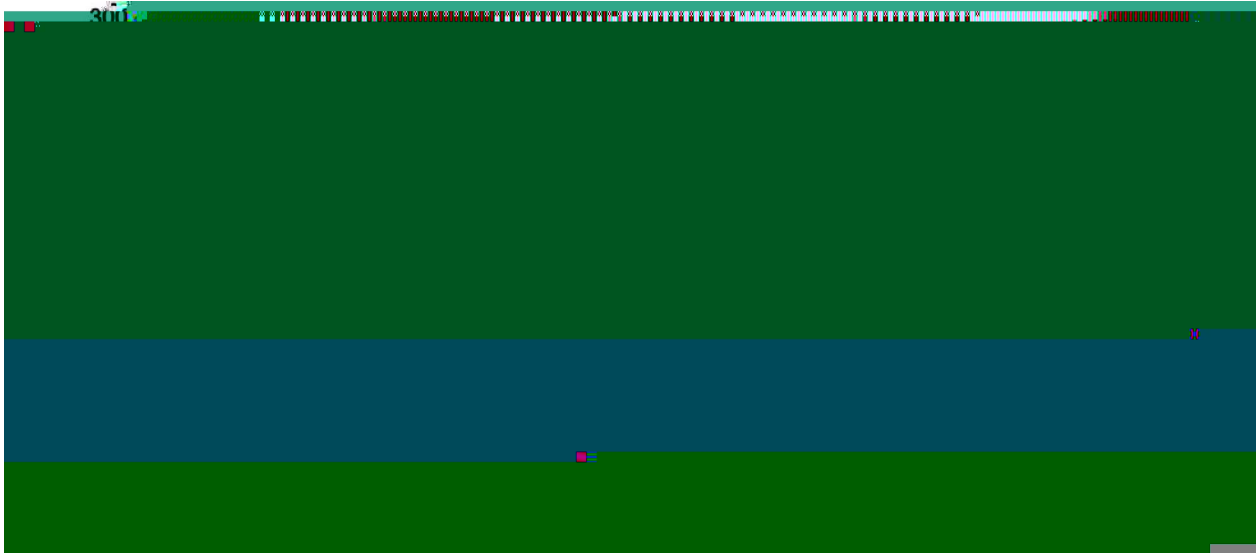

± ± ± ±

/ Resistance to Soldering Heat Test Conditions

± ± °C

/ Packaging SPEC.

封装形式	包装数量					包装尺寸 :		
	只袋	袋盒	只盒	盒箱	只箱	袋	盒	箱

封装形式	包装数量			包装尺寸 :	
	只纸带	纸带盒	纸带	纸带	