

LV10150JCT

Rev.E Mar.-2016

/ Descriptions

TO-220S

Schottky diode in a TO-220S Plastic Package.

/ Features

Low forward voltage drop, low power losses, High efficiency operation.

/ Applications

OR-ing

DC-DC

For use in high frequency inverters, switching power supplies, freewheeling diodes, OR-ing diode, dc-to-dc converters and reverse battery protection.

/ Equivalent Circuit

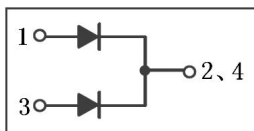

/ Pinning

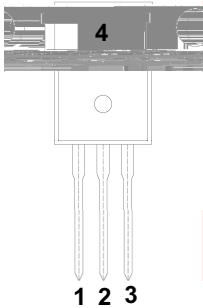

PIN1 Anode

PIN 2 Cathode

PIN 3 Anode

PIN 4 NC

/ h_{FE} Classifications & Marking

See Marking Instructions.

LV10150JCT

Rev.E Mar.-2016

Parameter	Symbol	Rating	Unit
Peak Repetitive Reverse Voltage Working Peak Reverse Voltage DC Blocking Voltage	V_{RRM} V_{RSM} V_{DC}	150	V
RMS Reverse Voltage	V_{RMS}	105	V
Average Rectified Forward Current	$I_{F(AV)}$	2X5	A
Non Repetitive Peak Surge Current	I_{FSM}	80	A
Thermal Resistance Junction to Case	$R_{\theta Jc}$	3.5	/W
Junction and Storage Temperature Range	$T_j T_{stg}$	-55~+150	

Parameter Symbol Test Conditions

/ **Electrical Characteristic Curve**

IF - TC

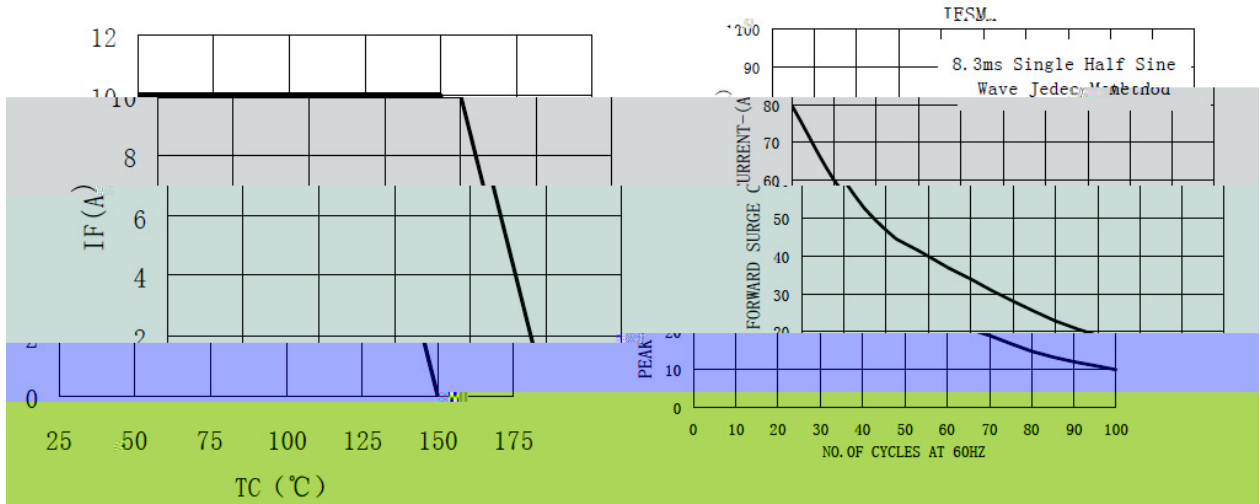

IF - VF

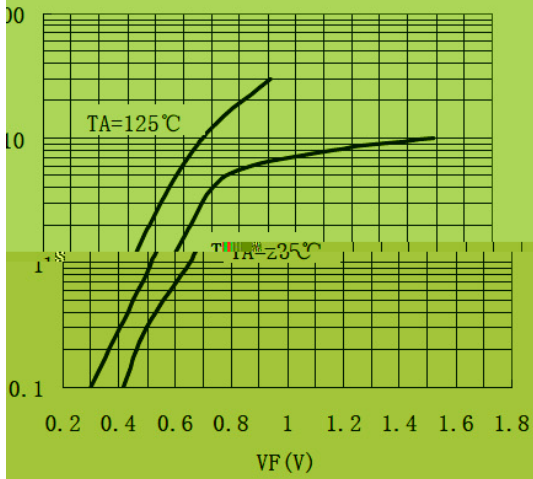

IR - VR

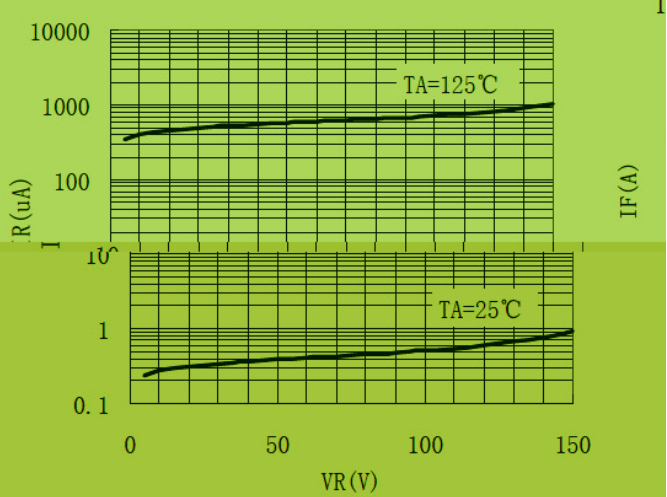

CJ - VR

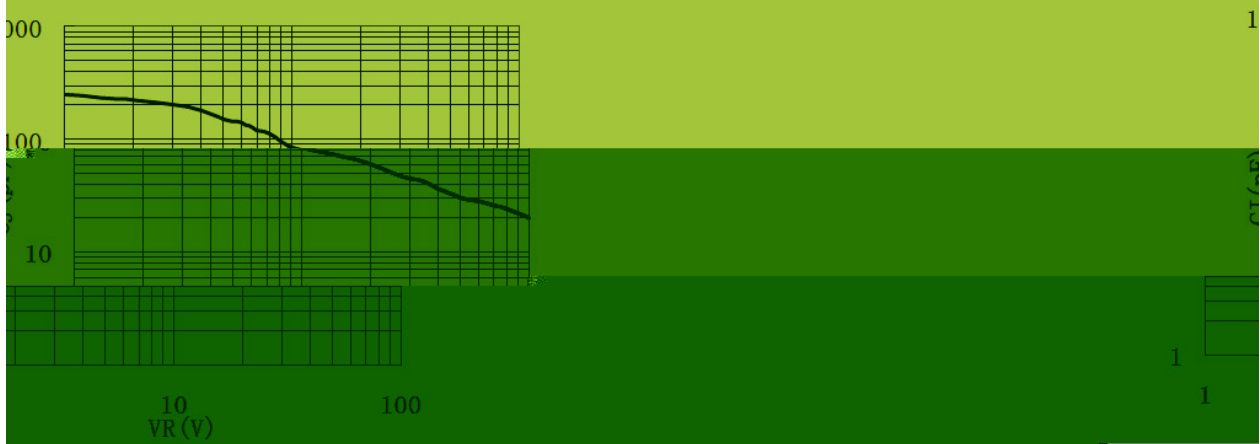

/ Package Dimensions

TO-220S

Unit: mm

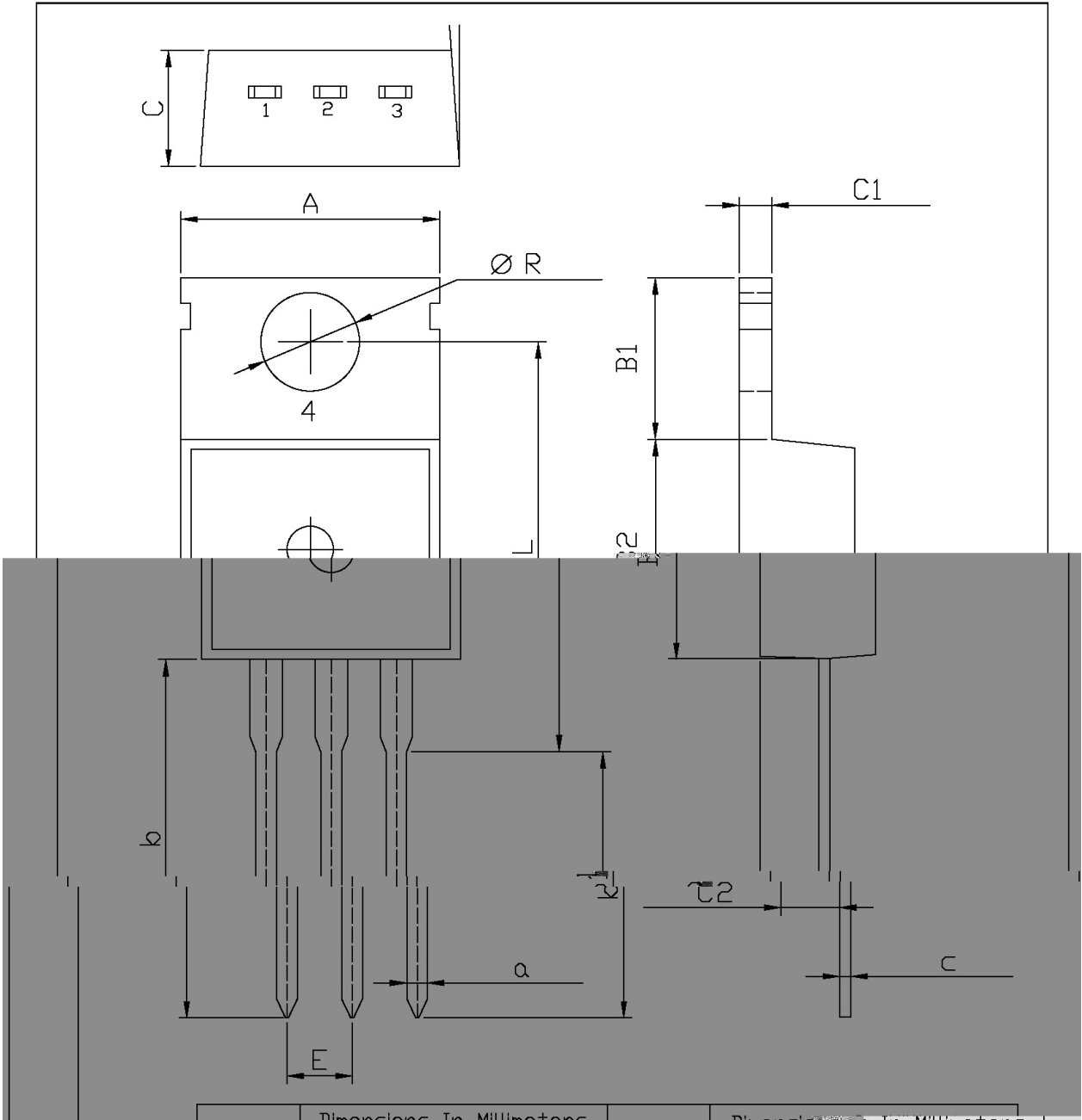

Dimensions in Millimeters			Dimensions in Millimeters		
Symbol	Min.	Max.	Symbol	Min.	Max.

LV10150JCT

Rev.E Mar.-2016

() / **Temperature Profile for Dip Soldering(Pb-Free)**

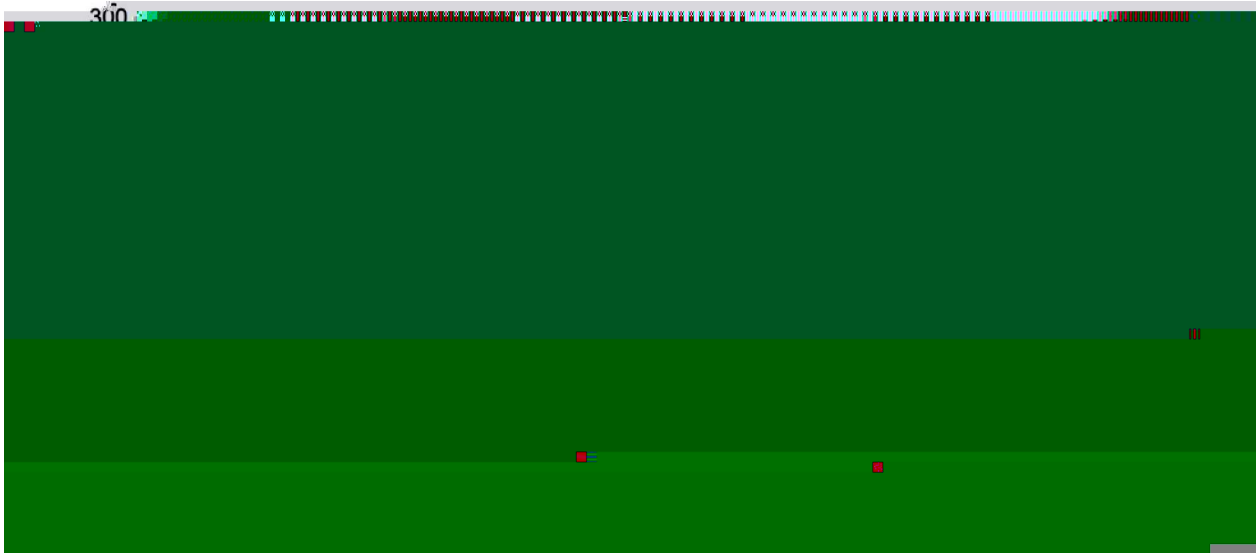

Note:

- | | | | | | |
|---|-------|-----|-----------|--------|---|
| 1 | 25 | 150 | 60 | 90sec; | 1.Preheating:25~150 , Time:60~90sec. |
| 2 | 255±5 | | 5±0.5sec; | | 2.Peak Temp.:255±5 , Duration:5±0.5sec. |
| 3 | | 2 | 10 | /sec. | 3. Cooling Speed: 2~10 /sec. |

/ **Resistance to Soldering Heat Test Conditions**

270±5 10±1 sec. Temp.:270±5 Time:10±1 sec

/ **Packaging SPEC.**

/ TUBE

Package Type 封装形式	Units 包装数量					Dimension 包装尺寸 (unit: mm ³)		
	Units/Tube 只/套管	Tubes/Inner Box 套管/盒	Units/Inner Box 只/盒	Inner Boxes/Outer Box 盒/箱	Units/Outer Box 只/箱	Tube 套管	Inner Box 盒	Outer Box 箱
TO-220S	50	20	1000	5	5000	532×31.4×5.5	555×164×50	575×290×180

/ **Notices**