

/ Descriptions

KF \$))'
TO-220 Plastic package Schottky diode .

/ Features

Low forward voltage drop,low power losses,High efficiency operation.

/ Applications

For use in high frequency inverters, switching power supplies, freewheeling diodes, OR-ing diode, dc-to-dc converters and reverse battery protection.

/ Equivalent Circuit

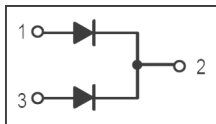

/ Pinning

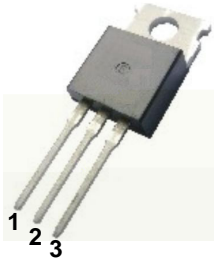

PIN1 Anode PIN 2 Cathode PIN 3 Anode

/ h_{FE} Classifications & Marking

See Marking Instructions.

| Parameter | Symbol | Rating | Unit |
|---|------------------------------------|----------|------|
| Peak Repetitive Reverse Voltage Working Peak Reverse Voltage DC Reverse Voltage | V_{RRM} V_{RWM} V_{DC} | 45 | V |
| RMS Reverse Voltage | V_{RMS} | 31.5 | V |
| Average forward rectified Current | I_F | 2 X 10 | A |
| Non Repetitive Peak Surge Current | I_{FSM} | 160 | A |
| Thermal Resistance Junction to Case | R_{Jc} | 2.8 | /W |
| Junction and Storage Temperature Range | $T_j T_{stg}$ | -40~+150 | |

| Parameter | Symbol | Test Conditions | Min | Typ | Max | Unit |
|-----------------|-------------|-------------------------|-----|------|-----|------|
| Reverse Voltage | $V_{(BR)R}$ | $I_R = 1mA$ $T_a = 25$ | 45 | | | V |
| Forward Voltage | V_{FM} | $I_F = 5.0A$ $T_a = 25$ | | 0.38 | | V |
| | | $I_F = 10A$ $T_a = 25$ | | | | |

/ Electrical Characteristic Curve

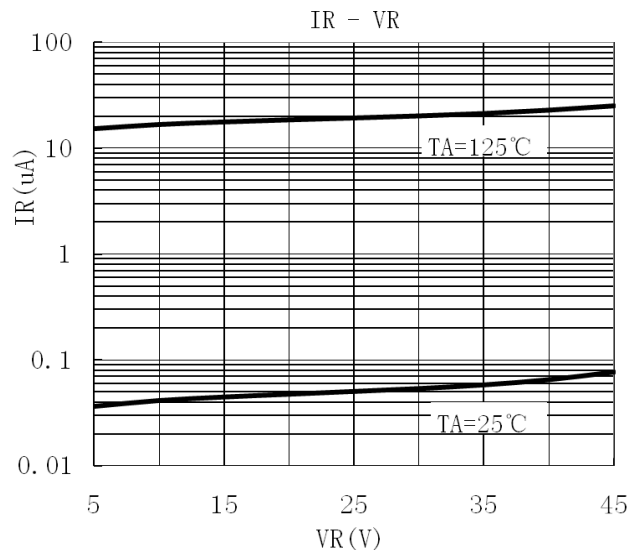
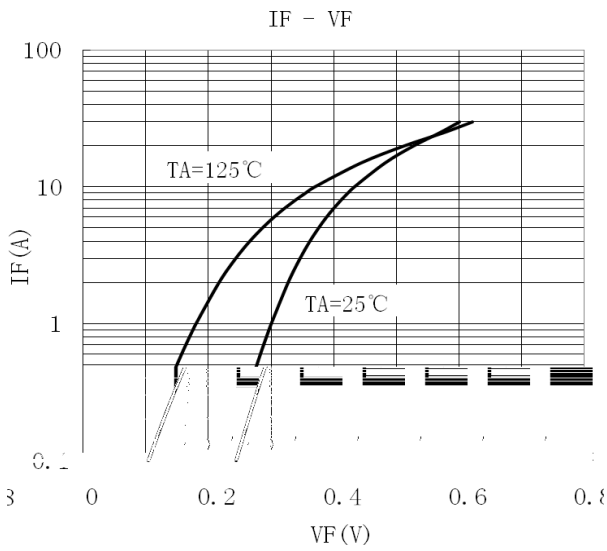
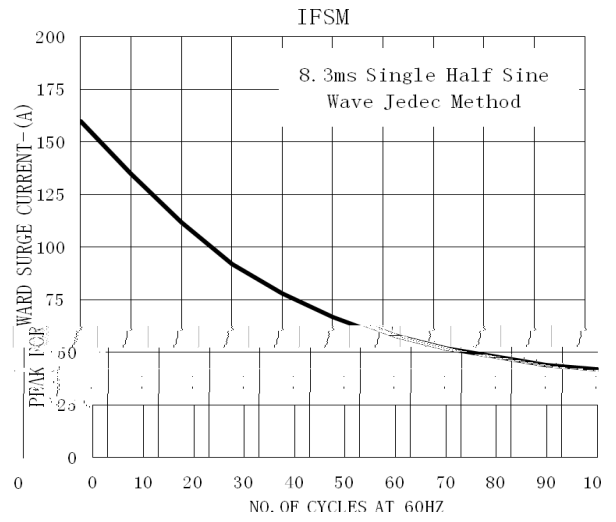
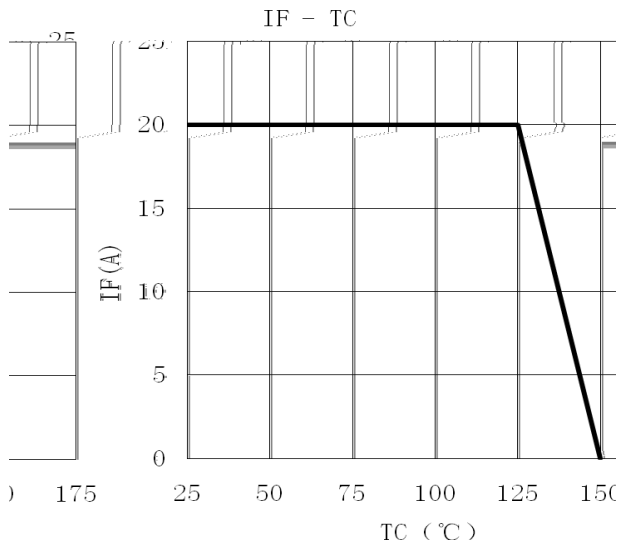

/ Package Dimensions

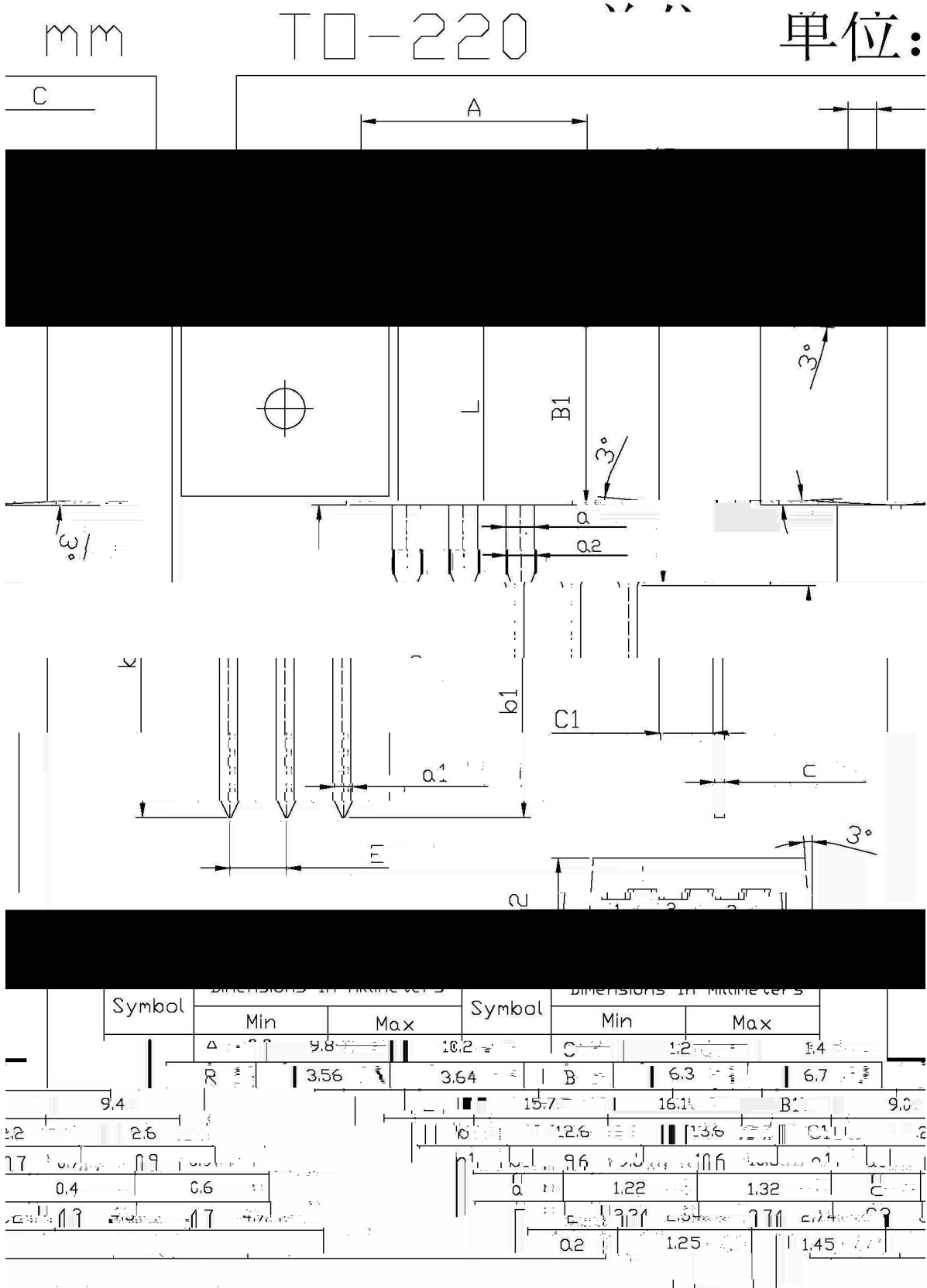

/ Marking Instructions

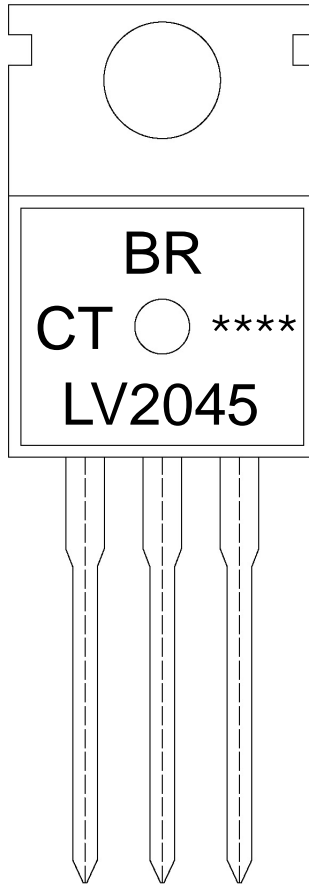

91

CM +,

: K1

!!!!

Note:

BR: Company Code

CM +, Product Type.

: K: Internal Structure

****: Lot No. Code, code change with Lot No.

() / Temperature Profile for Dip Soldering(Pb-Free)



Note:

- | | | | | | |
|---|--------|-----|------------|--------|---|
| 1 | 25 | 150 | 60 | 90sec; | 1.Preheating:25~150 , Time:60~90sec. |
| 2 | 255..5 | | 5..0.5sec; | | 2.Peak Temp.:255..5 , Duration:5..0.5sec. |
| 3 | | 2 | 10 | /sec. | 3. Cooling Speed: 2~10 /sec. |

/ Resistance to Soldering Heat Test Conditions

270..5 10..1 sec. Temp.:270±5 Time:10±1 sec

/ Packaging SPEC.

/ BULK

| Package Type 封装形式 | Units 包装数量 | | | | | Dimension 包装尺寸 (unit: mm ³) | | |
|----------------------|------------------|-----------------------|------------------------|------------------------------|------------------------|---|-------------|-------------|
| | Units/Bag 只/袋 | Bags/Inner Box 袋/盒 | Units/Inner Box 只/盒 | Inner Boxes/Outer Box 盒/箱 | Units/Outer Box 只/箱 | Bag 袋 | Inner Box 盒 | Outer Box 箱 |
| TO-220/F | 200 | 10 | 2,000 | 5 | 10,000 | 135×190 | 237×172×102 | 560×245×195 |

/ TUBE

| Package Type 封装形式 | Units 包装数量 | | | | | Dimension 包装尺寸 (unit: mm ³) | | |
|----------------------|--------------------|-------------------------|------------------------|------------------------------|------------------------|---|-------------|-------------|
| | Units/Tube 只/套管 | Tubes/Inner Box 套管/盒 | Units/Inner Box 只/盒 | Inner Boxes/Outer Box 盒/箱 | Units/Outer Box 只/箱 | Tube 套管 | Inner Box 盒 | Outer Box 箱 |
| TO-220/F | 50 | 20 | 1,000 | 5 | 5,000 | 532×31.4×5.5 | 555×164×50 | 575×290×180 |

/ Notices