

MBR20200CT-44

Rev.A Mar.-2025

/ Descriptions

TO-220

Schottky Barrier Diode in a TO-220 Plastic Package, Adopt new mold.

/ Features

Low power loss, high efficiency, HF product.

/ Applications

For use in low voltage,high frequency inverters, free wheeling, and polarity protection applications.

/ Equivalent Circuit

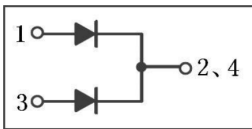

/ Pinning

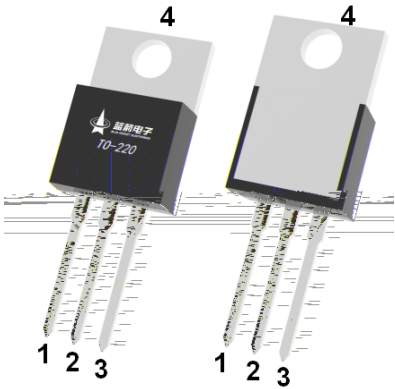

PIN1 Anode

PIN 2 Cathode

PIN 3 Anode

/ Marking

See Marking Instructions.

/ Absolute Maximum Ratings(Ta=25)

Parameter	Symbol	Rating	Unit
Peak Repetitive Reverse Voltage	V_{RRM}	200	V
Working Peak Reverse Voltage	V_{RWM}	200	V
Average Rectified Output Current @60Hz sine wave,R-load, Ta=25	I_o	20	A
Non-Repetitive Peak Forward Surge Current	I_{FSM}	150	A
Current Squared Time @1ms $t < 8.3ms$ $T_j = 25$	I^2T	94	A S
Thermal Resistance Junction to Case	R_{Jc}	2.0	/W
Junction Temperature Range	T_j	175	
Storage Temperature Range	T_{stg}	-55 175	

/ Electrical Characteristics(Ta=25)

Parameter	Symbol	Test Conditions	Min	Typ	Max	Unit
Forward Voltage	V_F	$I_F = 10A(T_j = 25)$			0.95	V
Instantaneous Reverse Current	I_R	$V_R = 200V(T_j = 25)$			0.1	mA
		$V_R = 200V(T_j = 125)$			20	mA

/ Electrical Characteristic Curve

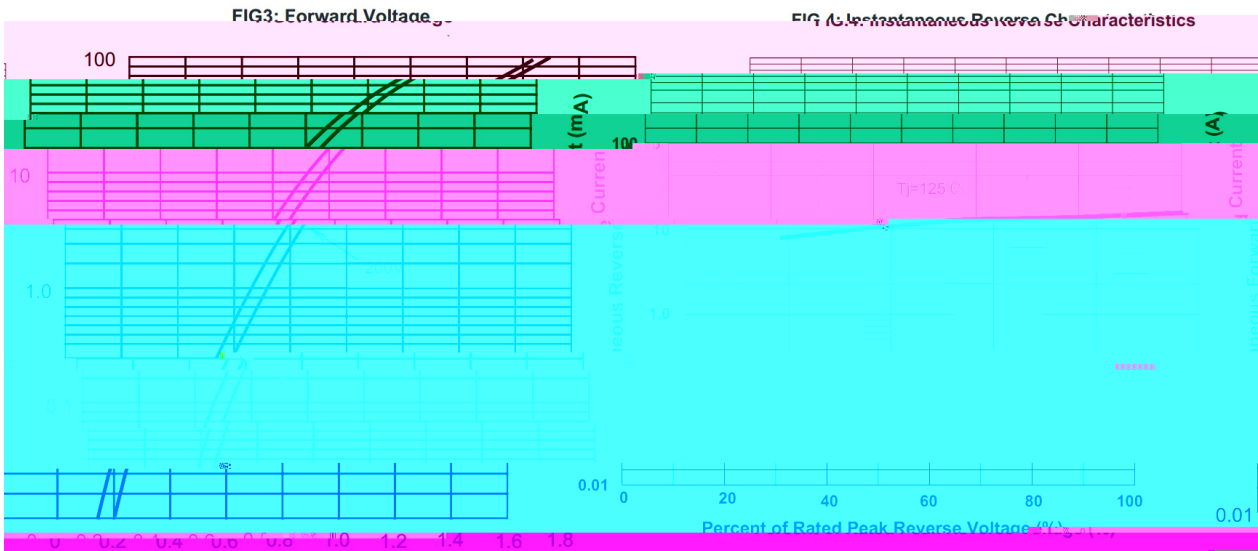
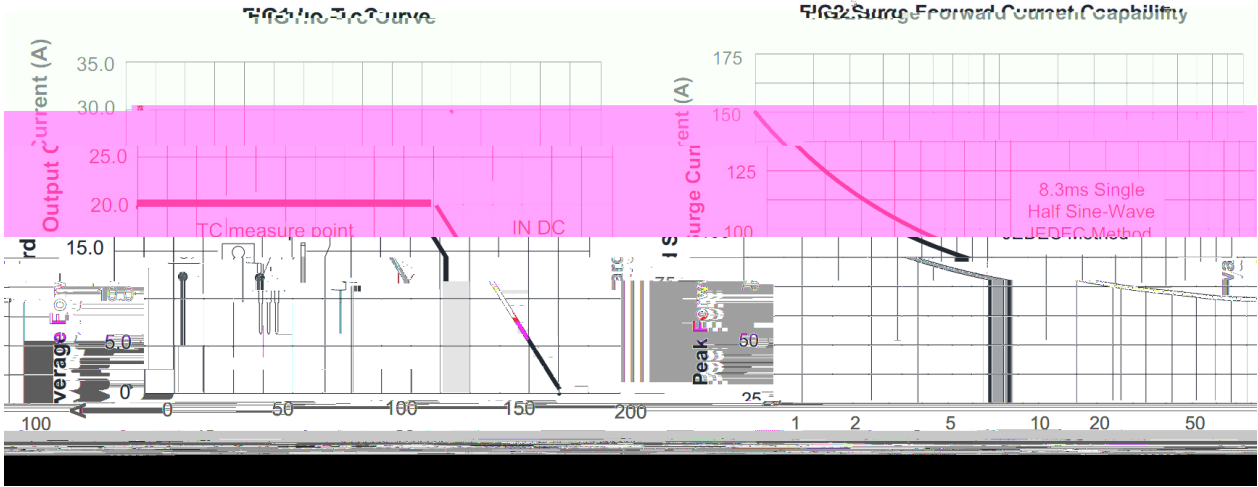

/ Package Dimensions

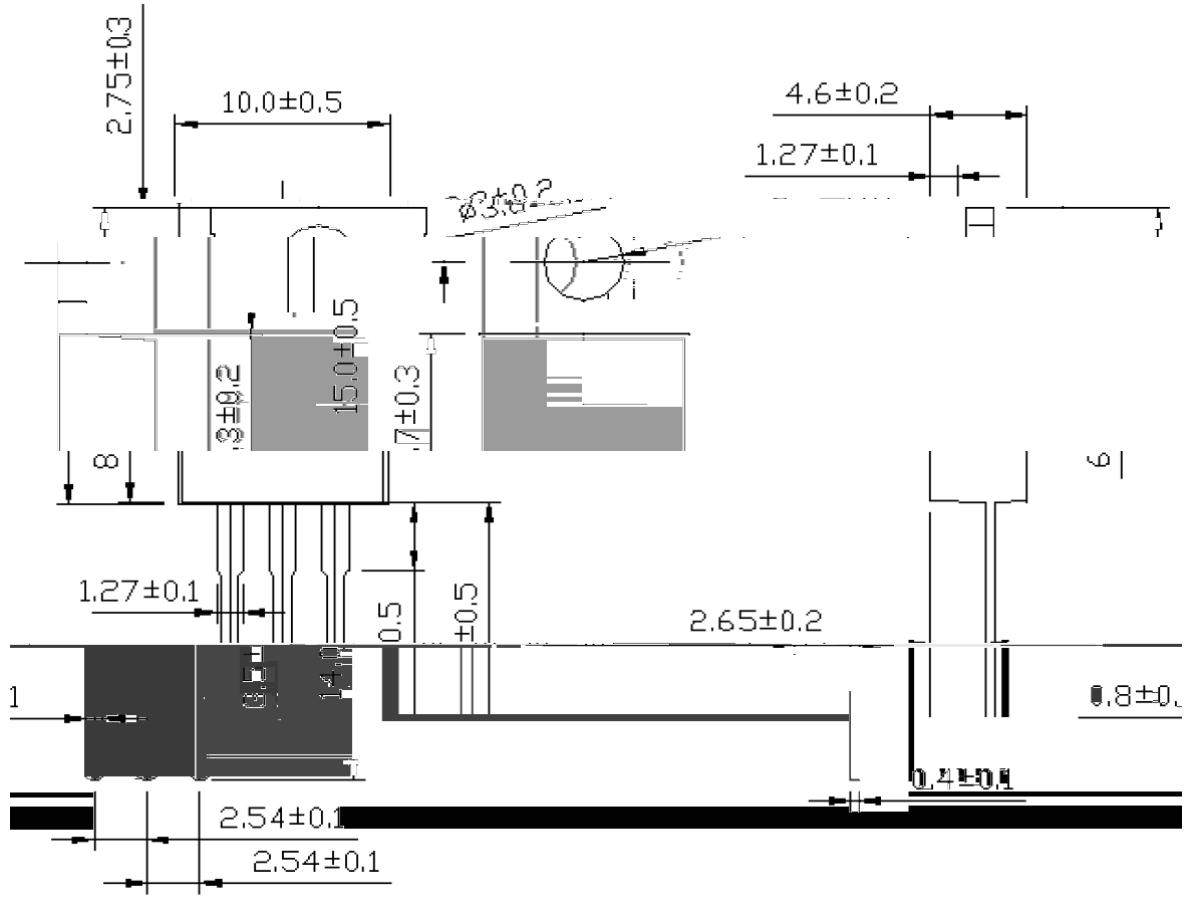

Dimensions in millimeters (1mm =0.0394")

MBR20200CT-44

Rev.A Mar.-2025

/ Marking Instructions

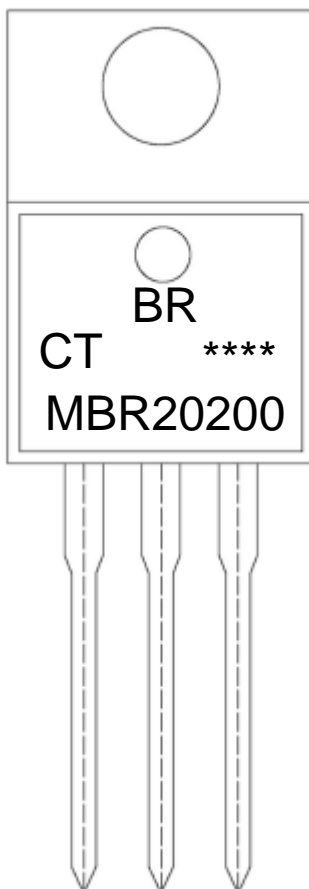

BR

MBR20200

CT:

Note:

BR: Company Code

MBR20200 Product Type Code

CT: Internal Structure

****: Lot No. Code, code change with Lot No

() / Temperature Profile for Dip Soldering(Pb-Free)

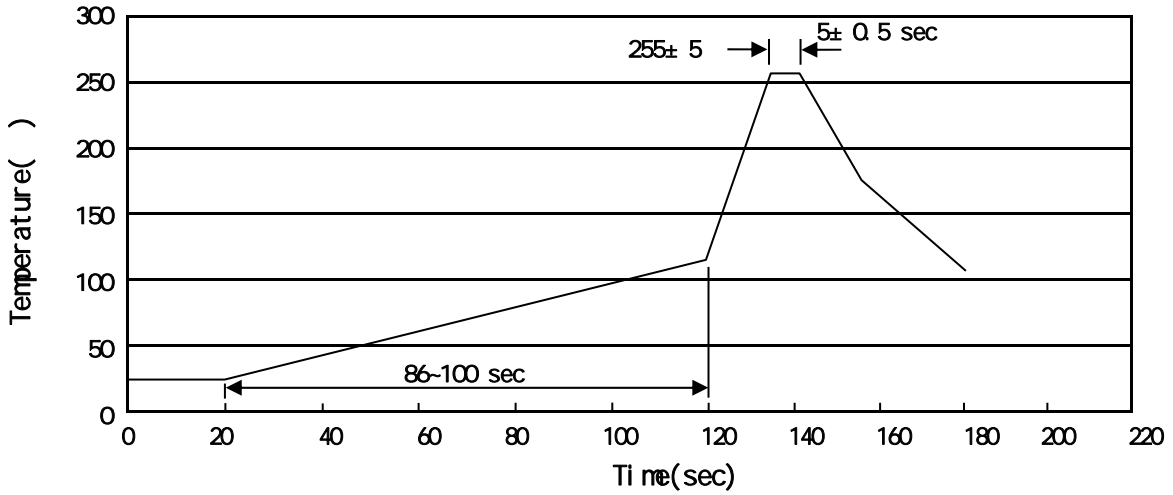

Note:

- | | | | |
|---|--------|-----------|--|
| 1 | 25-150 | 60-90sec; | 1. Preheating: 25~150 , Time: 60~90sec. |
| 2 | 255±5 | 5±0.5sec; | 2. Peak Temp.: 255±5 , Duration: 5±0.5sec. |
| 3 | 2-10 | /sec. | 3. Cooling Speed: 2~10 /sec. |

/ Resistance to Soldering Heat Test Conditions

270±5 10±1 sec. Temp.: 270±5 Time: 10±1 sec

/ Packaging SPEC.

/ BULK

Package Type 封装形式	Units 包装数量					Dimension 包装尺寸 (unit: mm ³)		
	Units/Bag 只/袋	Bags/Inner Box 袋/盒	Units/Inner Box 只/盒	Inner Boxes/Outer Box 盒/箱	Units/Outer Box 只/箱	Bag 袋	Inner Box 盒	Outer Box 箱
TO-220/F	200	10	2,000	5	10,000	135x190	237x172x102	560x245x195

/ TUBE

Package Type 封装形式	Units 包装数量					Dimension 包装尺寸 (unit: mm ³)		
	Units/Tube 只/套管	Tubes/Inner Box 套管/盒	Units/Inner Box 只/盒	Inner Boxes/Outer Box 盒/箱	Units/Outer Box 只/箱	Tube 套管	Inner Box 盒	Outer Box 箱
TO-220/F	50	20	1,000	5	5,000	532x31.4x5.5	555x164x50	575x290x180

/ Notices