

/ Descriptions

TO-252

/ Features

/ Applications

/ Equivalent Circuit

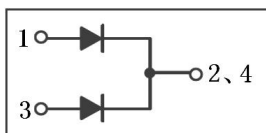

/ Pinning

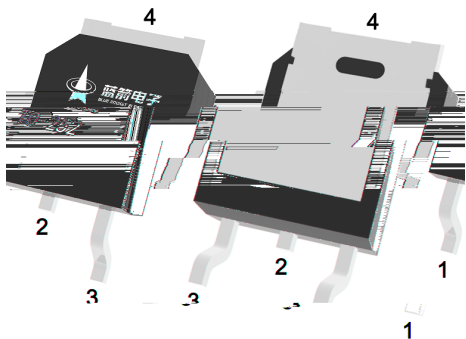

/ Marking

/ Electrical Characteristic Curve

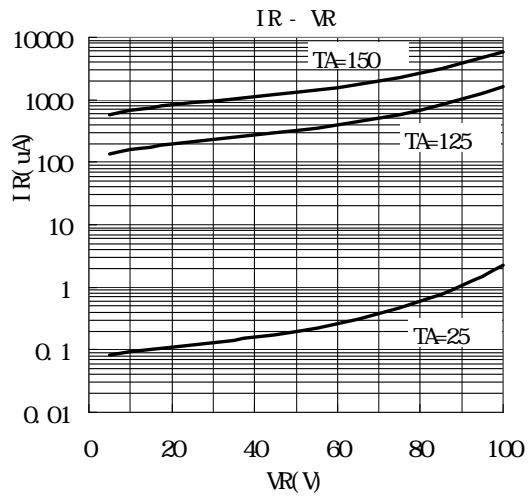
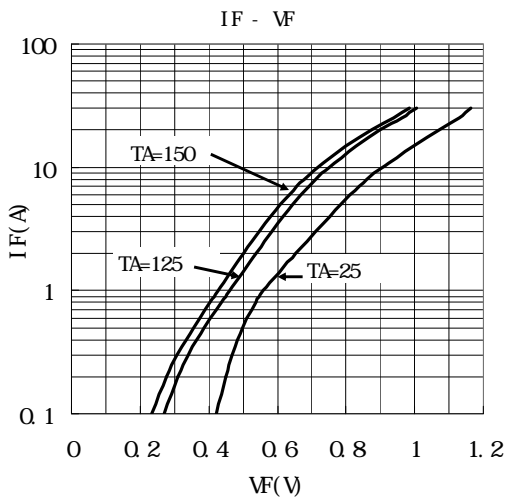
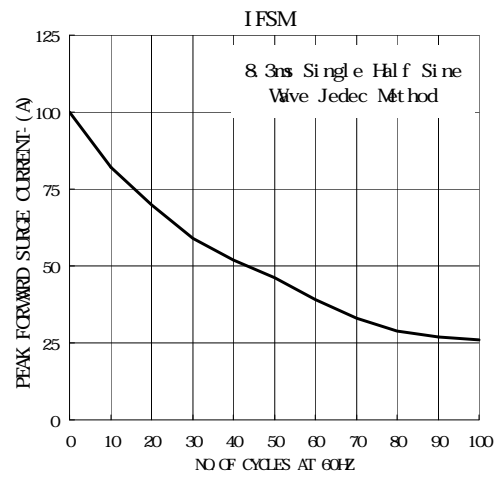
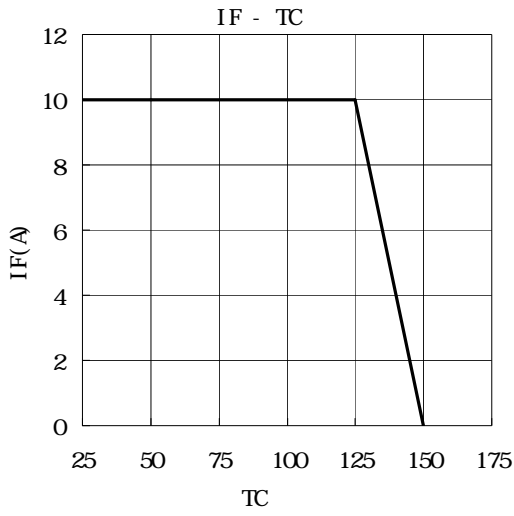

/ Package Dimensions

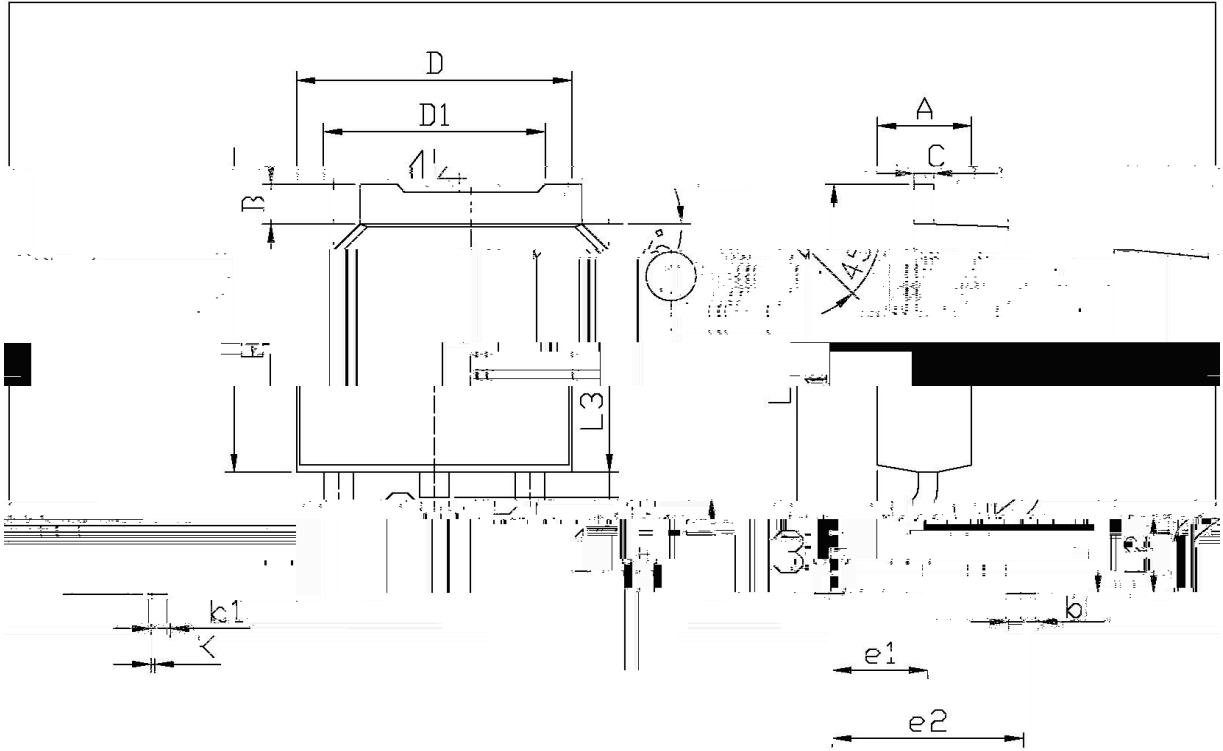

单位: mm

Symbol	Dimensions In Millimeters		Symbol	Dimensions In Millimeters	
	Min	Max		Min	Max
A	5.95	6.25	A	2.20	2.40
B	2.24	2.34	B	0.95	1.25
C	4.43	4.73	C	0.70	0.90
D	0.55	0.85	D	0.45	0.70
D1	0.45	0.55	D1	1.70	2.00
H	0.60	0.90	H	6.45	6.75
L3	0.60	0.90	L3	5.50	5.75
k1	0.50	0.60	k1	0.50	0.60
e1	1.27	1.27	e1	1.27	1.27
e2	2.54	2.54	e2	2.54	2.54

□-252

/ Marking Instructions

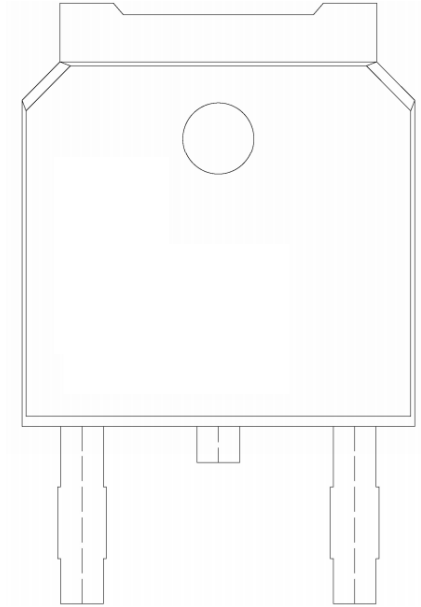

BR

MBRD10100

CT:

() / Temperature Profile for IR Reflow Soldering(Pb-Free)

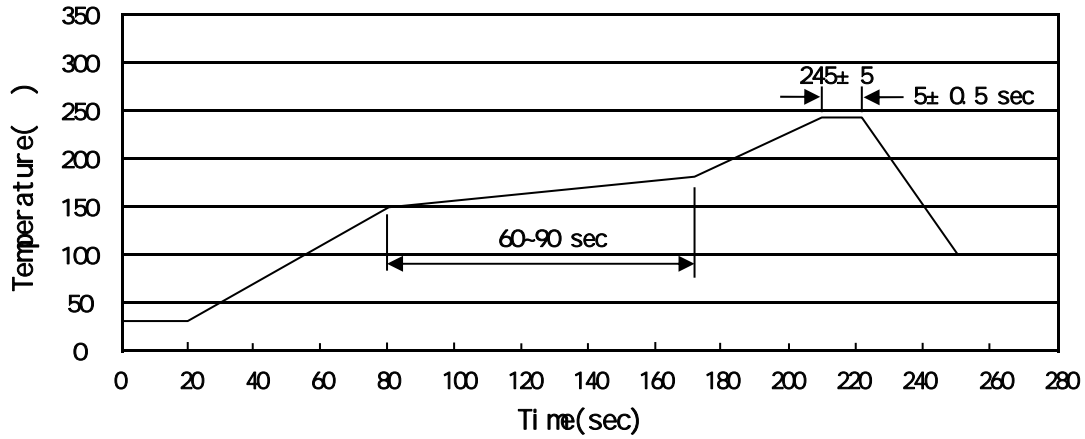

± ± ± ±

/ Resistance to Soldering Heat Test Conditions

± ±

/ Packaging SPEC.

	Units/Reel	Reels/Inner Box	Units/Inner Box	Inner Boxes/Outer Box	Units/Outer Box	Reel	Inner Box	Outer Box
	/	/	/	/	/			

	Units/Tube	Tubes/Inner Box	Units/Inner Box	Inner Boxes/Outer Box	Units/Outer Box	Tube	Inner Box	Outer Box
	/	/	/	/	/			

/ Notices