

/ Descriptions

/ Features

/ Applications

/ Equivalent Circuit

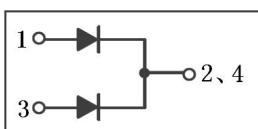

/ Pinning

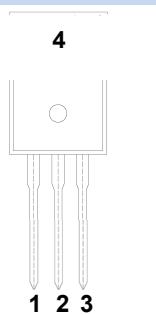

/ h_{FE} Classifications & Marking

MBRJ10100CT

/ Electrical Characteristic Curve

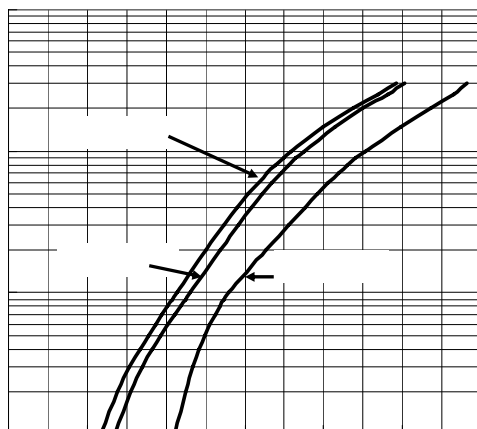
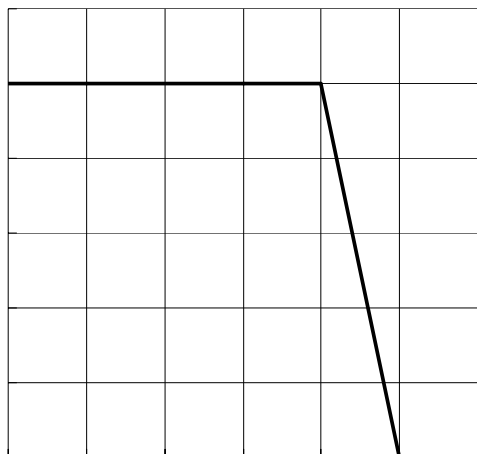

/ Package Dimensions

TO-220S

Unit: mm

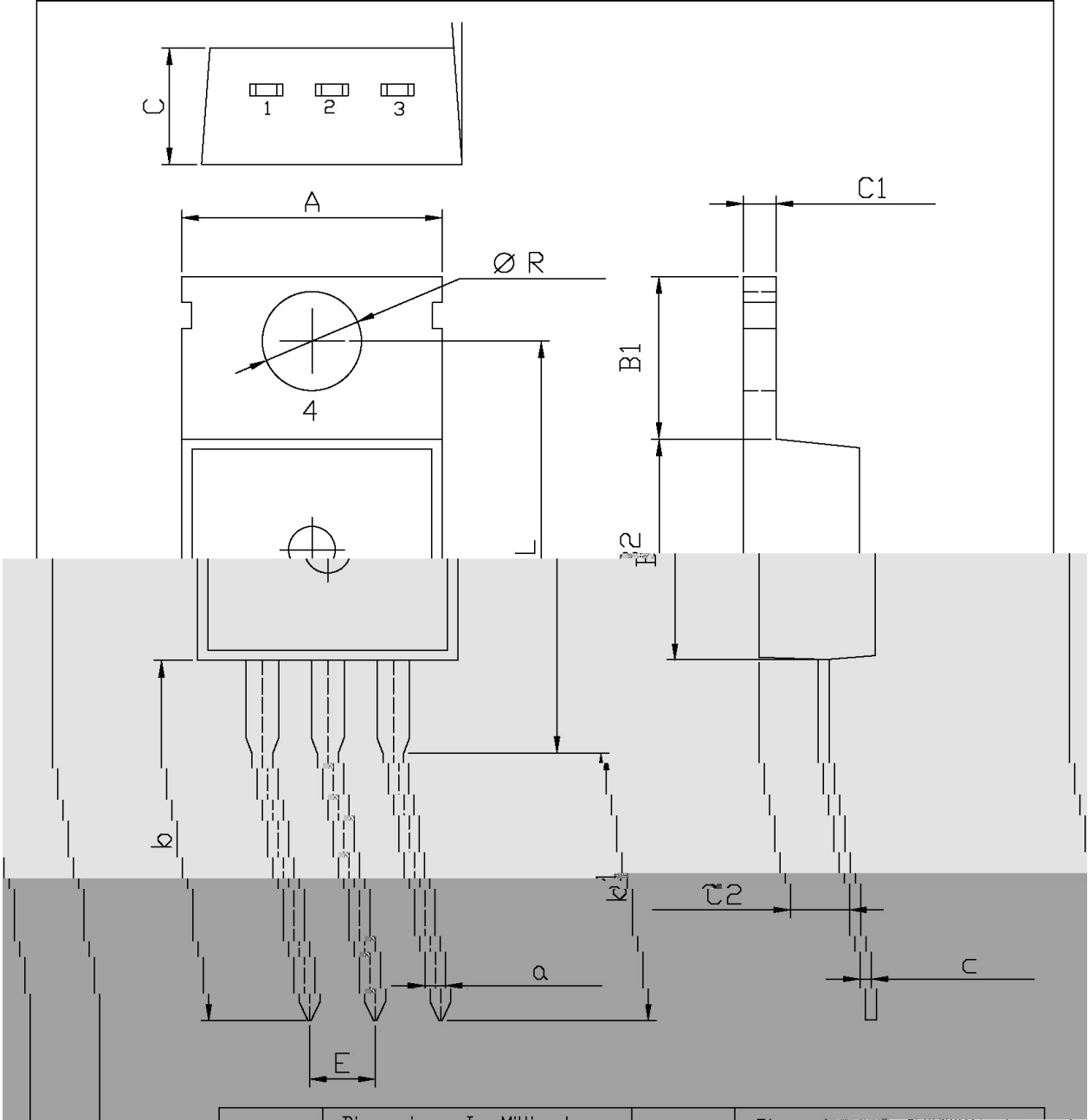

Dimensions In Millimeters			Dimensions In Millimeters		
Symbol	Min.	Max.	Symbol	Min.	Max.

/ Marking Instructions

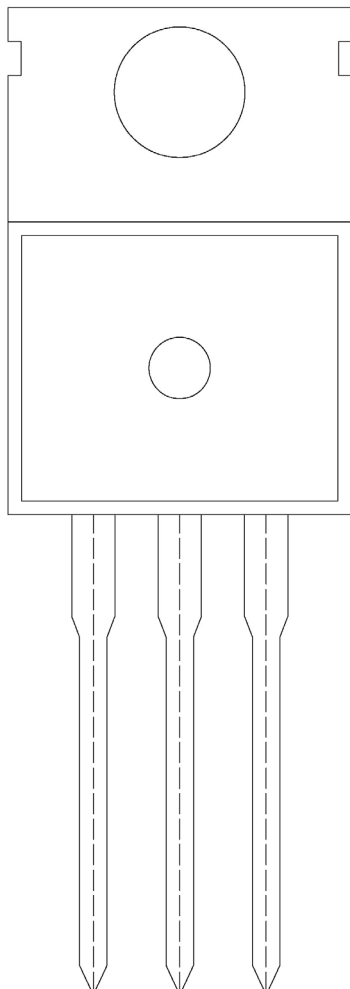

() / Temperature Profile for Dip Soldering(Pb-Free)

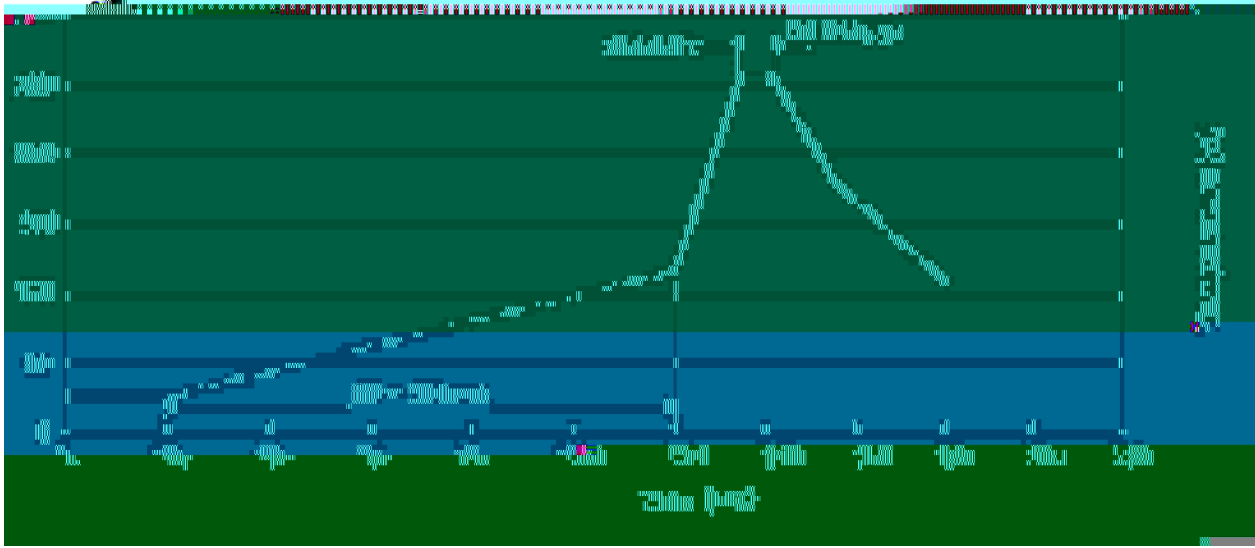

/ Resistance to Soldering Heat Test Conditions

°C

/ Packaging SPEC.

封装形式	包装数量					包装尺寸 :		
	Units/Tube 只/套管	Tubes/Inner Box 套管/盒	Units/Inner Box 只/盒	Inner Boxes/Outer Box 盒/箱	Units/Outer Box 只/箱	Tube 套管	Inner Box 盒	Outer Box 箱
TO-220S	50	20	1000	5	5000	532×31.4×5.5	555×164×50	575×290×180

/ Notices